

INDUSTRIAL PLUG SOCKET
SUPPLIER OF GLOBAL HIGH-END INDUSTRIAL CONNECTING DEVICES
www.cnsfe.com



INDUSTRIAL PLUG SOCKET

SUPPLIER OF GLOBAL HIGH-END INDUSTRIAL CONNECTING DEVICES

全球高端工业接插装供应商

www.cnsfe.com



温州市上丰电气有限公司
WENZHOU SHANGFENG ELECTRIC CO.,LTD

地址: 浙江省乐清经济开发区纬五路199号
ADD: No.199 Weiwu Road, Economic Development Zone,
Yueqing, Zhejiang, China
电话(Tel): 0577-61752511 61752611
传真(Fax): 0577-61757211

销售中心: 柳市中国电器城2单元287号
Sells center: NO.287, unit 2, china electrical appliance city, liushi.
电话(Tel): 0577-62757305
销售中心: 柳市新电器城152号
Sells center: NO.152, New electrical appliance city, liushi.
电话(Tel): 0577-61758565
Http://www.cnsfe.com
E-mail: shangfeng@cnsfe.com



本手册采用生态纸印刷 2021.01

本手册供产品选型参考, 产品图片及安装尺寸以实物为准,
如有改动不作另行通知, 不承担任何法律责任。

企业简介 INTRODUCTION

+ WENZHOU SHANGFENG ELECTRIC
CO.,LTD.

- 温州市上丰电气有限公司

温州市上丰电气有限公司座落在“中国电器之都”——柳市，毗邻甬台温高速公路和104国道，南临温州最大港口—七里港口，西临温州飞机场和火车站，海陆空交通十分便利。

本公司引进先进技术和设备，通过ISO9001国际质量体系、中国质量认证中心CQC认证并获得欧共体CE安全认证，ROHS环保指令认证，不断引进高级技术人才和企业管理人才，已逐渐具备一流的生产工艺。公司专业生产工业插头、插座、耦合器(连接器)，尼龙扎带等产品，公司严格按照IEC60309、EN60309、CEE17等国际标准 and GB11918、GB11919等国家标准，产品设计独特，结构合理。

产品主要应用于：钢铁冶炼、石油化工、电力、电子、铁路、建筑工地、机场、矿山、采矿场、给排水处理厂以及港口、码头、商场、宾馆等各类工矿企业和作为国外引进设备电源、接插件的配套和维修备件，是新一代的理想电源装置。本公司产品畅销国内外二十多个省市自治区以及东南亚、欧洲、美洲等国家地区，倍受客商青睐。

本公司始终坚持以“质量求生存、信誉求发展”的宗旨，不断开拓进取，创一流的质量，具一流的服务，以“上丰”牌产品拓展全球市场。

Wenzhou Shangfeng Electric co.,ltd.is located in Liushi well known as Chinese electric Appliance Capital, colsed to Yong-Tai-Wen Highway and 104 national way,south to the biggest port in Wenzhou-xili port, west to Wenzhou Airport and Railway Station, so the traffic is very convenient.

The company import advanced technology and devices, conform with requirement of ISO9001 international quality system, have passed CQC certification, CE certification, ROHS - appliance, employ senior technical talents and enterprise management talents, have possessed first-rank processing technology gradually. The company specialize in producing industrial plug, socket, coupler, nylon tape and so on, follow IEC60309, EN60309, CEE17 international standard and the structure is reasonable.

The product is applied for kinds of industrial and mining enterprises such as steel smelting, petrochemical industry, electric power, electron, railway, construction, airport, mine, stope, water supply and drain processing factory, port, store, hotel and so on, and it is also for mating and maintenance fittings of device power and connectors imported from abroad, so it is a new generation ideal power supply unit. The products are sold to over 20 provinces, municipalities and autonomous regions in our country, and southeast Asia, European, Americal and so on areas as well, they are quite enjoyed by clients.

The company always insist on the tenet that " quality to seek for living ,credit to find development " in order to improve and develop continuously, produce exceptional product, give the excellent service, extend the global market relying on " shangfeng " brand products.

DO THE TOP-GRADE BUSINESS ENTERPRISE,
做一流企业，树优秀品牌
EXCELLENT BRAND OF

+
TREE

精良的生产设备

先进的自动化生产设备，流水线精良制作，尽显一流品质。技术专家直接参与生产，保证产品的稳定性和可靠性万无一失。

始终坚持为用户提供更优质的产品为准则，以不断的开发满足用户需求和为用户提供更好的服务宗旨，愿与新老客户保持长期友好的合作关系，互惠互利，共同发展。

SOPHISTICATED PRODUCTION EQUIPMENT

Advanced automated production equipment, pipeline, well-primuced a full first-class quality. Technical experts directly involved in production to ensure product stability and reliability foolproof. Always insist on better quality products provide users with as a criterion, better service purposes, Wiling to work with the new and old customers to maintain long-term friendly relations of cooperation, mutual benefit and common development.

www.cnsfe.com

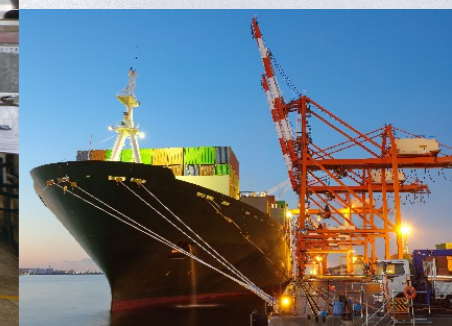

以成熟的技术和可靠的产品质量服务用户

Mature technology and reliable product quality to service customers



满足用户需求，为用户提供符合标准和用户要求的优质产品，公司对进厂原材料全面跟踪检测，确保每个零部件技术指标和性能符合设计要求。强化生产过程控制，严格执行工艺文件，确保产品的电气性能和机械性能的一致性。严格执行入库产品最终检验程序，实行一票否决制，时刻保证产品质量。

Meet user demand, to provide high-quality products in accordance with standards and user requirements, the company of raw materials into the factory tracking detection, to ensure that technical index and performance of every parts and components meet the design requirements. Strengthening production process control, strictly enforce process files, to ensure the consistency of product electrical performance and mechanical performance. Strictly implement storage products final inspection procedure and execute one ticket is overruled make, time to ensure the quality of products.

“质量是企业的生命”公司对弘扬企业文化，贯彻质保体系，对外传达企业精神，树立品牌概念。为确保产品质量，公司配备了一流的生产和产品检测设备。我们拥有世界先进的生产装备。运用崭新的工业概念及强大的技术力量，生产出符合国际标准的高品质终极产品。

“Quality is the life of the enterprise”. The company carries forward the enterprise culture and implements quality guarantee system internally, and transmits enterprise spirit and establishes brand conception externally. To ensure product quality, our company has been equipped with first class production and inspection equipment. We will produce high quality ultimate products that are in accordance with international standards by adopting world advanced production equipment, brand new industrial conception and powerful technical strength.

精工细作，资质为证

Qualification proves the elaborate manufacturing

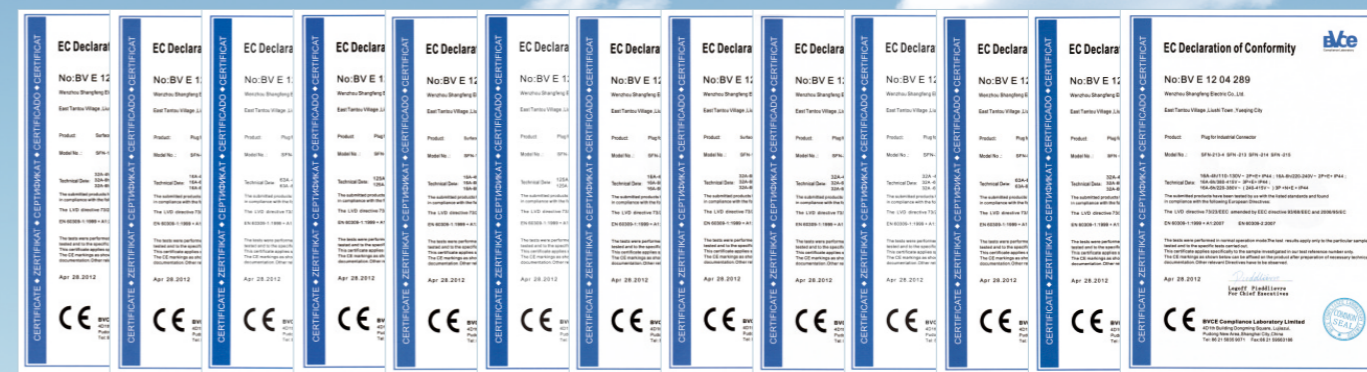
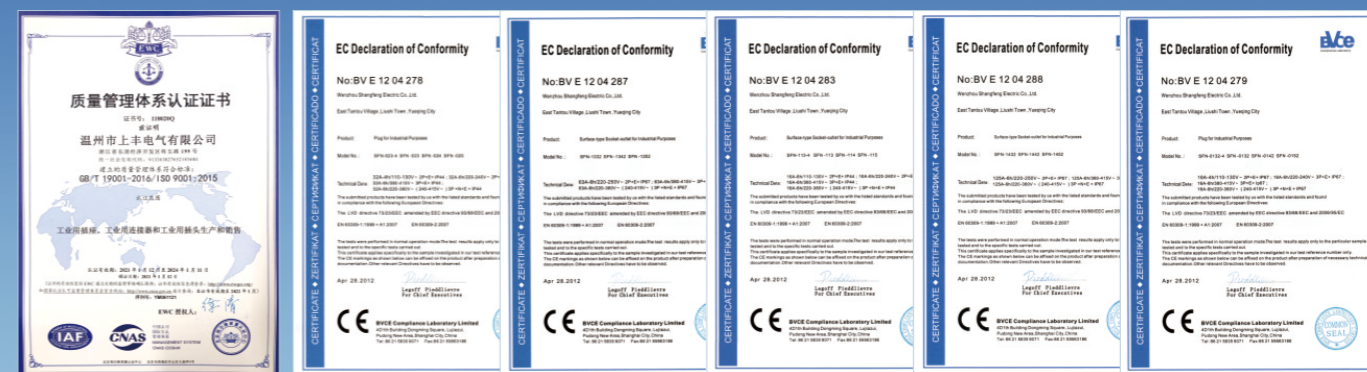

Position of the earthing contact acc. to IEC 60309-2

Spannung V	Frequency Hz	2P+E		3P+E		3P+N+E	
		16+32A	63+125A	16+32A	63+125A	16+32A	63+125A
63,5/110 bis 75/130	50+60					4	4
110 bis 130	50+60	4	4	4	4		
120/208 bis 144/130	50+60					9	9
220 bis 250	50+60	6	6	9	9		
220/380 bis 240/130	50+60					6	6
220/380 bis 250/440	50+60					3	3*
250/400 bis 265/460	60					11	11
277	60	5	5				
277/480 bis 280/130	50+60					7	7
347/600 bis 400/690	50+60					5	5
380 bis 415	50+60	9	9	6	6		
380; 440	50+60			3	3*		
440 bis 460	60			11	11		
480 bis 500	50+60	7	7	7	7		
600 bis 690	50+60			5	5		
über 50	100 bis 300	10*	10*	10*	10*	10*	10*
über 50	>300 bis 500	2	2*	2	2*	2	2
ber 50 bis 250	Gleichstrom	3	3				
über 250	Gleichstrom	8	8				
Versorgung nach Trenntransformator	50+60	12	12	12	12		

* nicht standard

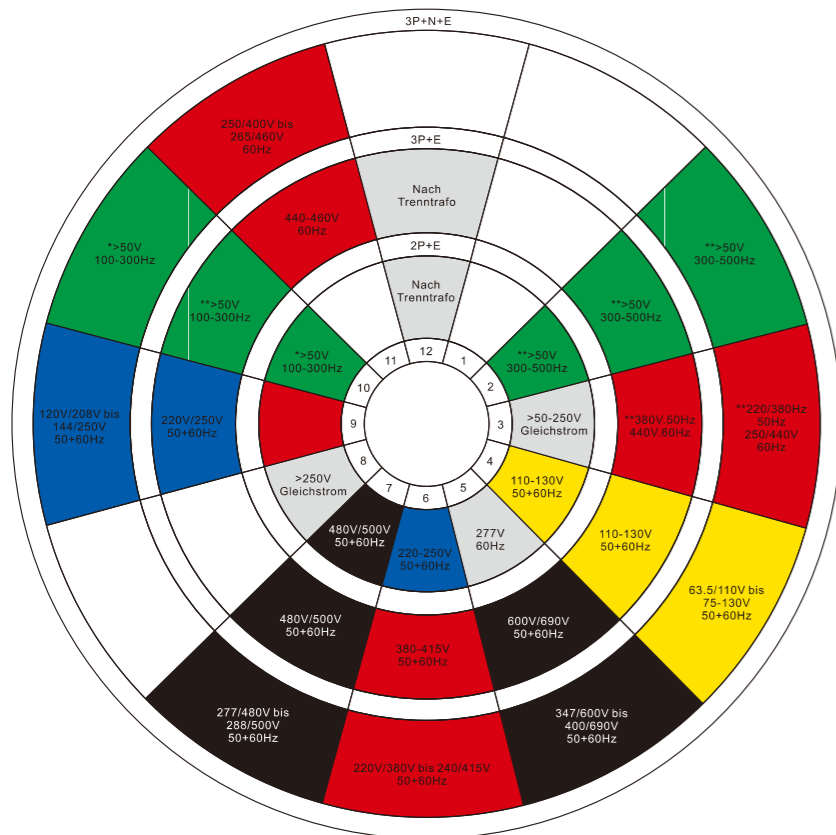

IEC 60309 plugs and socket-outlets for industrial use standards

SF系列工业插头和插座符合以下国际标准: IEC60309-1和IEC60309-2, CEIEN60309-1和CEIEN60309-2, 也符合VDE0623和BS4343.

SF series industrial plugs and socket-outlets are in compliance with the following international standards: IEC60309-1 & IEC60309-2, CEIEN60306-1 & CEIEN60309-2

They are also in compliance with the standards: VDE 0623, BS4343.

优点 Advantage

该产品具有很好的绝缘性能, 具有防水、防尘、防溅、防腐抗老化等特点, 并有先进的设计, 因而适用于IP44和IP67等级所需要的环境中。

Nennbetriebs spannung	Kenfarbe
20-25V	Violett
40-50V	weiß
100-130V	gelb
200-250V	blau
380-480V	rot
500-690V	schwarz
> 60-500Hz	grün
ohne kenfarbe	gra

位置或接地点

图: 正面插座或连接件

Position or the earthing contact.

View: frontside socket or connector

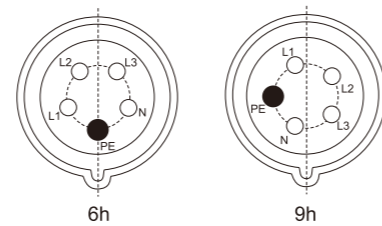

* keine standardausführung

** keine standardausführung für 63A, 125A

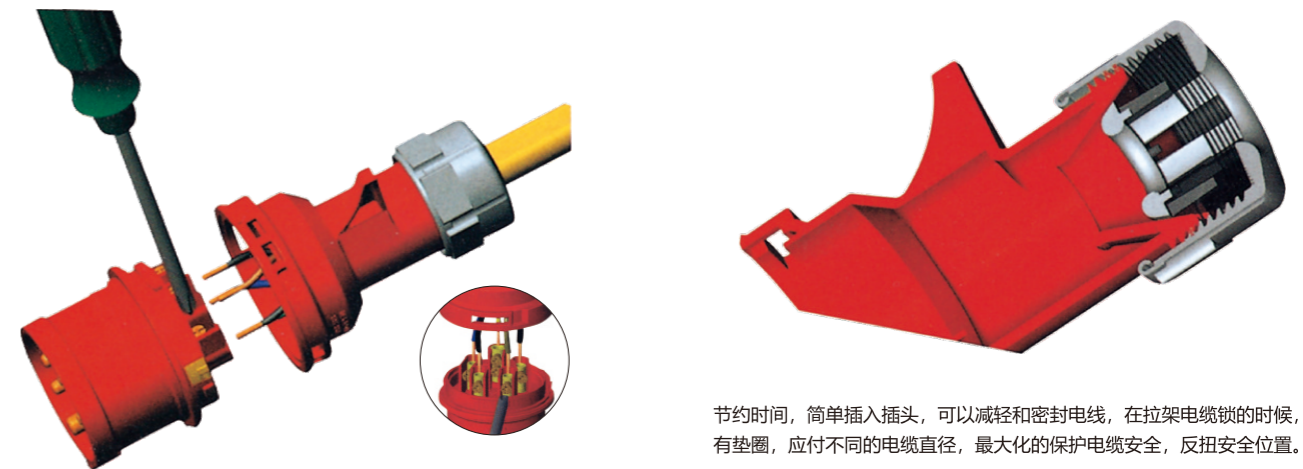
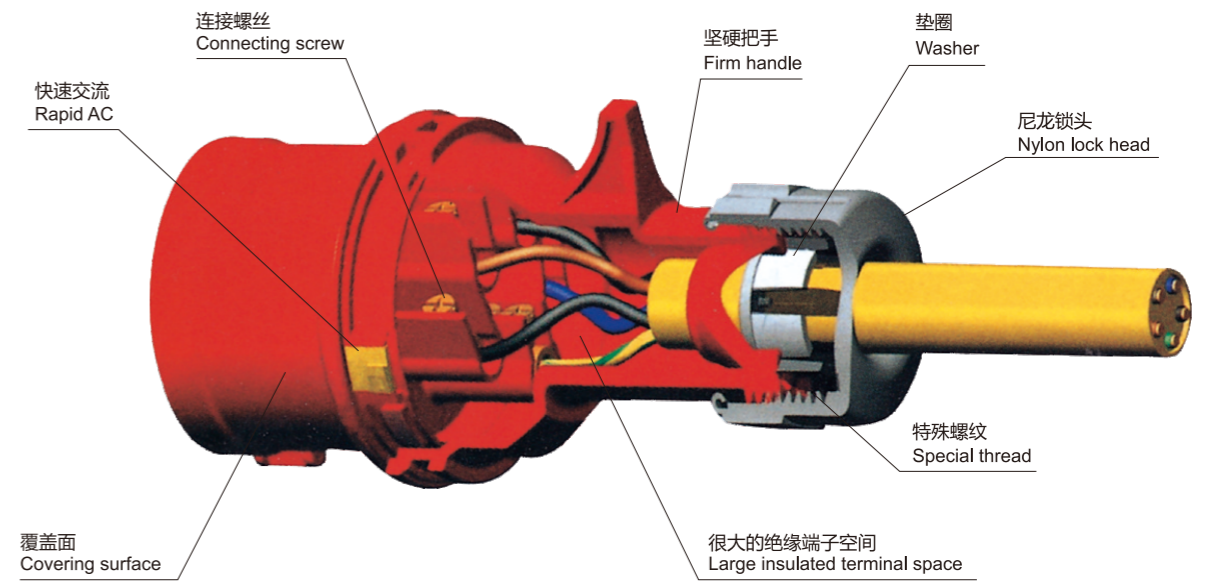

可以从一个方向达到, 可以锁可以开。
May reach from one direction, in addition, can be locked and opened.

节约时间, 简单插入插头, 可以减轻和密封电线, 在拉架电缆锁的时候, 有垫圈, 应付不同的电缆直径, 最大化的保护电缆安全, 反扭安全位置。
Save time, simply insert into the plug, lighten with sealing wire, besides, a washer parting the cable lock which can adapt to different cables diameters, protect the cable to the max extent and inversely twisting the safety position.

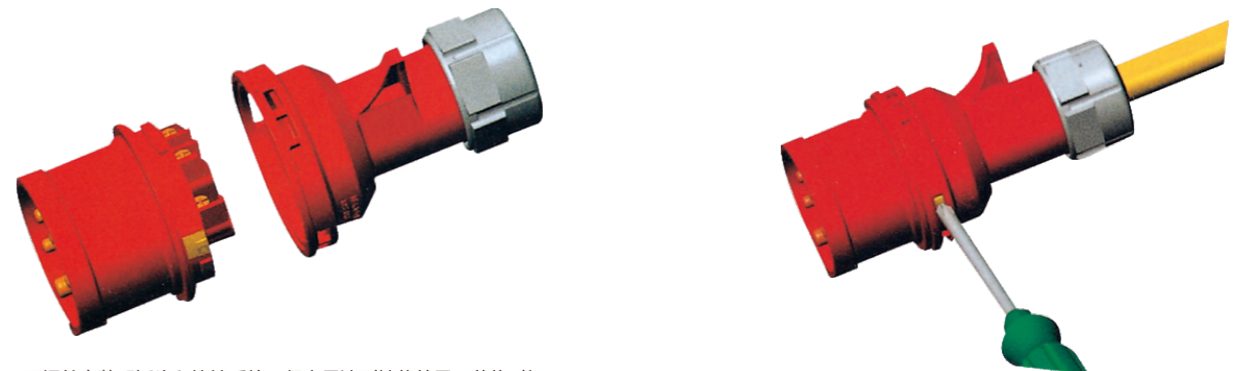

不用螺丝去装配插头和快锁系统, 很容易达到锁住效果, 节约时间。
Because the plug and rapid lock system aren't assembled with screw, they also can be locked easily, the time can be saved.

简单解锁和转动打开。
Open the lock simply and can be opened through rotating.

CE/IEC国际标准 插头
符合欧洲/国际标准 EN/IEC 60309-2



SFK-247 SFK-259

earth contact position	4h		
rated current(A)	16	32	
	pole 3		
	a	140	173
	b	116	144
	c	43.5	57
dimension(mm)	d	38.5	51
	e	17.5	25
	f	47	62
	g	58	80.7
cable nominal cross-section area(mm ²)	1.5-2.5	4-6	

电 流 Current(A): 16A, 32A
电 压 Voltage(V): 110-130V~2P+E
防护等级 Protection degree: IP44

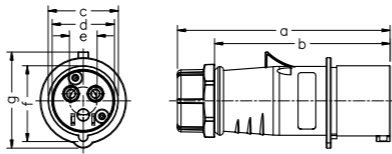

SFK-248 SFK-260

earth contact position	6h		
rated current(A)	16	32	
	pole 3		
	a	140	173
	b	116	144
	c	43.5	57
dimension(mm)	d	38.5	51
	e	17.5	25
	f	47	62
	g	58	80.7
cable nominal cross-section area(mm ²)	1.5-2.5	4-6	

电 流 Current(A): 16A, 32A
电 压 Voltage(V): 220-240V~2P+E
防护等级 Protection degree: IP44

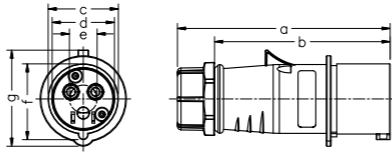

SFK-252 SFK-264

earth contact position	6h		
rated current(A)	16	32	
	pole 4		
	a	140	173
	b	116	144
	c	49.5	57
dimension(mm)	d	43.8	51
	e	21.5	25
	f	52	62
	g	66.7	80.7
cable nominal cross-section area(mm ²)	1.5-2.5	4-6	

电 流 Current(A): 16A, 32A
电 压 Voltage(V): 380-415V~3P+E
防护等级 Protection degree: IP44

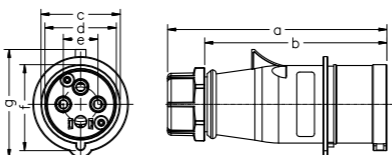

SFK-3 SFK-4

earth contact position	6h		
rated current(A)	16	32	
	pole 5		
	a	144	173
	b	121	144
	c	56	63.3
dimension(mm)	d	50	56.5
	e	26.5	30.3
	f	60	68.7
	g	75	89
cable nominal cross-section area(mm ²)	1.5-2.5	4-6	

电 流 Current(A): 16A, 32A
电 压 Voltage(V): 220-380V~
240-415V~ 3P+N+E
防护等级 Protection degree: IP44

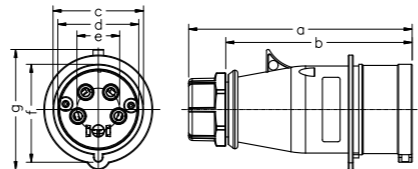

SFK-1226

earth contact position	4h		
rated current(A)	63		
	pole 3		
	a	238.9	170
	b	179.4	141
	c	66	32.5
dimension(mm)	d	100.1	93.3
	e	75.5	51
	f	36.5	25
	g	69.5	62.2
cable nominal cross-section area(mm ²)	10-16	4-6	

电 流 Current(A): 63A
电 压 Voltage(V): 110-130V~2P+E
防护等级 Protection degree: IP44

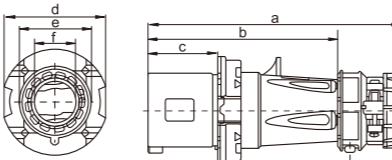

SFK-1227

earth contact position	6h		
rated current(A)	63		
	pole 3		
	a	238.9	170
	b	179.4	141
	c	66	32.5
dimension(mm)	d	100.1	93.3
	e	75.5	51
	f	36.5	25
	g	69.5	62.2
cable nominal cross-section area(mm ²)	10-16	4-6	

电 流 Current(A): 63A
电 压 Voltage(V): 220-240V~2P+E
防护等级 Protection degree: IP44

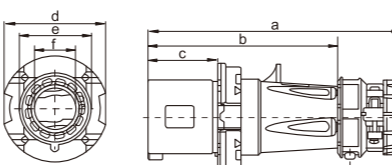

电 流 Current(A): 63A
电 压 Voltage(V): 380-415V~3P+E
防护等级 Protection degree: IP44

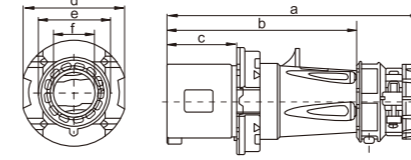

earth contact position	6h		
rated current(A)	63		
	pole 4		
	a	238.9	170
	b	179.4	141
	c	66	32.5
dimension(mm)	d	100.1	93.3
	e	75.5	51
	f	36.5	25
	g	69.5	62.2
cable nominal cross-section area(mm ²)	10-16	4-6	

SFK-1231

电 流 Current(A): 63A
电 压 Voltage(V): 220-380V~
240-415V~ 3P+N+E
防护等级 Protection degree: IP44

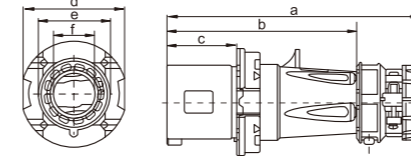

earth contact position	6h		
rated current(A)	63		
	pole 5		
	a	238.9	170
	b	179.4	141
	c	66	32.5
dimension(mm)	d	100.1	93.3
	e	75.5	51
	f	36.5	25
	g	69.5	62.2
cable nominal cross-section area(mm ²)	10-16	4-6	

SFK-1235

电 流 Current(A): 16A, 32A
电 压 Voltage(V): 110-130V~2P+E
防护等级 Protection degree: IP67

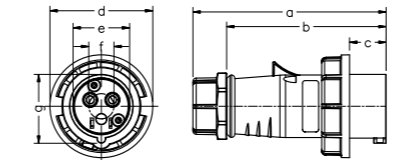

earth contact position	4h		
rated current(A)	16	32	
	pole 3		
	a	138	170
	b	115	141
	c	24.7	32.5
dimension(mm)	d	70.2	93.3
	e	38.3	51
	f	17.5	25
	g	47	62.2
cable nominal cross-section area(mm ²)	1.5-2.5	4-6	

SFK-277 SFK-289

电 流 Current(A): 16A, 32A
电 压 Voltage(V): 220-240V~2P+E
防护等级 Protection degree: IP67

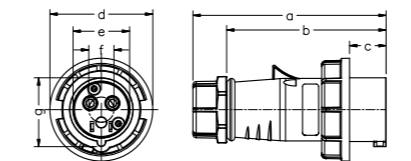

earth contact position	6h		
rated current(A)	16	32	
	pole 3		
	a	138	170
	b	115	141
	c	24.7	32.5
dimension(mm)	d	70.2	93.3
	e	38.3	51
	f	17.5	25
	g	47	62.2
cable nominal cross-section area(mm ²)	1.5-2.5	4-6	

SFK-278 SFK-290

电 流 Current(A): 16A, 32A
电 压 Voltage(V): 380-415V~3P+E
防护等级 Protection degree: IP67

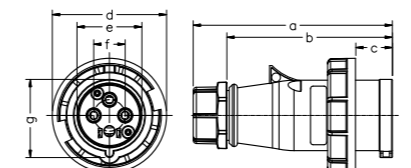

earth contact position	6h		
rated current(A)	16	32	
	pole 4		
	a	144	170
	b	120.5	141
	c	25.2	32.5
dimension(mm)	d	78	93.3
	e	43.8	51
	f	21.5	25
	g	52.2	62.2
cable nominal cross-section area(mm ²)	1.5-2.5	4-6	

SFK-282 SFK-294

电 流 Current(A): 16A, 32A
电 压 Voltage(V): 220-380V~
240-415V~ 3P+N+E
防护等级 Protection degree: IP67

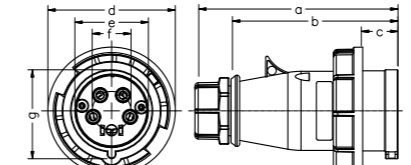

earth contact position	6h		
rated current(A)	16	32	
	pole 5		
	a	144	177
	b	120.5	148
	c	25.2	32.5
dimension(mm)	d	87	101
	e	50.2	56.5
	f	26.5	30.3
	g	60	68.7
cable nominal cross-section area(mm ²)	1.5-2.5	4-6	

SFK-288 SFK-300



earth contact position	4h	
rated current(A)	63	125
	pole 3	
dimension(mm)	a	238.9 286
	b	179.5 219
	c	51.1 57
	d	69.5 81.1
	e	113 131.5
	f	75.5 83.3
	g	36.5 42.5
cable nominal cross-section area(mm ²)	10-16	25-35

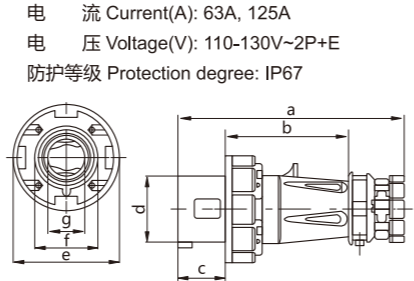

earth contact position	6h	
rated current(A)	63	125
	pole 3	
dimension(mm)	a	238.9 286
	b	179.5 219
	c	51.1 57
	d	69.5 81.1
	e	113 131.5
	f	75.5 83.3
	g	36.5 42.5
cable nominal cross-section area(mm ²)	10-16	25-35

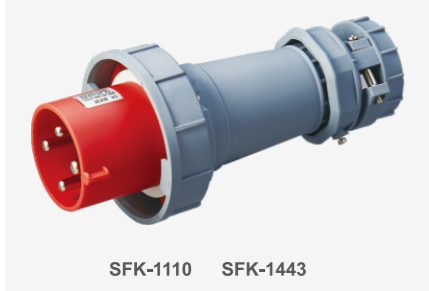
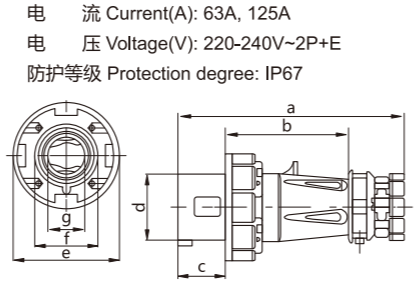

earth contact position	6h	
rated current(A)	63	125
	pole 4	
dimension(mm)	a	238.9 286
	b	179.5 219
	c	51.1 57
	d	69.5 81.1
	e	113 131.5
	f	75.5 83.3
	g	36.5 42.5
cable nominal cross-section area(mm ²)	10-16	25-35

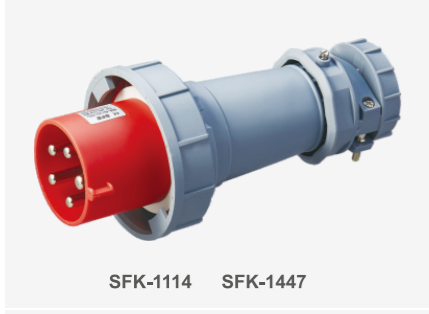
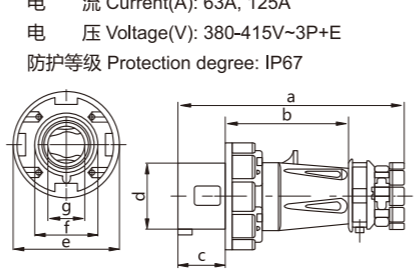

earth contact position	6h	
rated current(A)	63	125
	pole 5	
dimension(mm)	a	238.9 286
	b	179.5 219
	c	51.1 57
	d	69.5 81.1
	e	113 131.5
	f	75.5 83.3
	g	36.5 42.5
cable nominal cross-section area(mm ²)	10-16	25-35

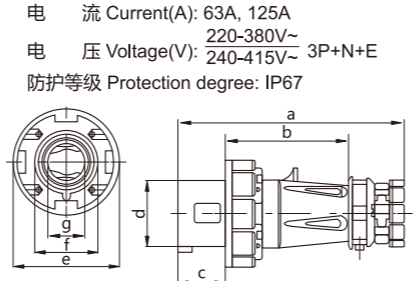

earth contact position	4h	
rated current(A)	16	32
	pole 3	
dimension(mm)	a	25° 25°
	b	127.9 156.4
	c	123.7 147.8
	d	94.6 120.7
	e	77.5 79
	f	88 98.5
	g	64.2 90.2
	M	M25 M32
M*	1个M25插头可剪断	1个M32插头可剪断
cable nominal cross-section area(mm ²)	1.5-2.5	4-6

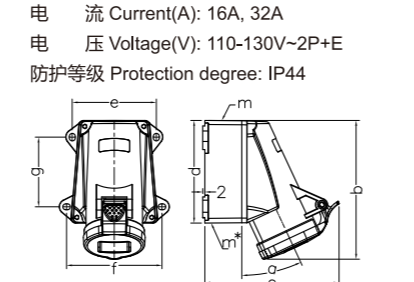

earth contact position	6h	
rated current(A)	16	32
	pole 3	
dimension(mm)	a	25° 25°
	b	127.9 156.4
	c	123.7 147.8
	d	94.6 120.7
	e	77.5 79
	f	88 98.5
	g	64.2 90.2
	M	M25 M32
M*	1个M25插头可剪断	1个M32插头可剪断
cable nominal cross-section area(mm ²)	1.5-2.5	4-6

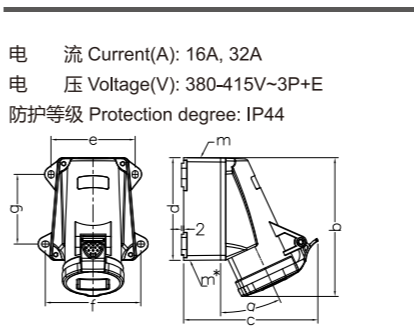
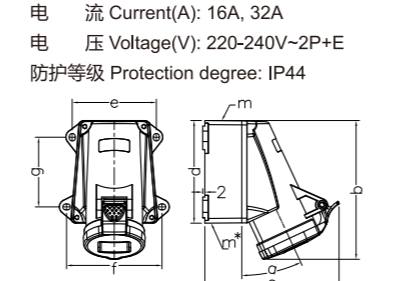

earth contact position	6h	
rated current(A)	16	32
	pole 4	
dimension(mm)	a	25° 25°
	b	129.9 156.4
	c	128.7 147.8
	d	94.6 120.7
	e	77.5 79
	f	88 98.5
	g	64.2 90.2
	M	M25 M32
M*	1个M25插头可剪断	1个M32插头可剪断
cable nominal cross-section area(mm ²)	1.5-2.5	4-6

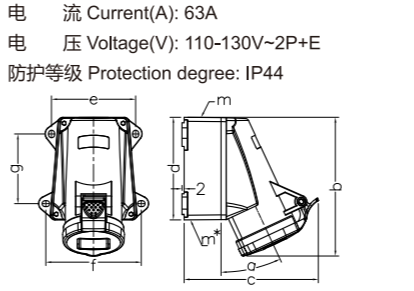
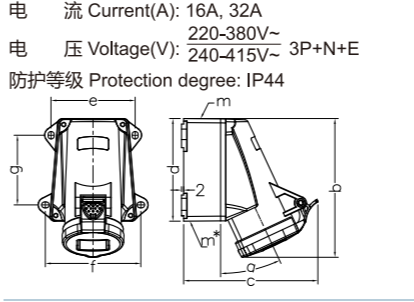

earth contact position	6h	
rated current(A)	16	32
	pole 5	
dimension(mm)	a	25° 25°
	b	135.4 158
	c	128.8 157.2
	d	94.6 120.7
	e	77.5 79
	f	88 98.5
	g	64.2 90.2
	M	M25 M32
M*	1个M25插头可剪断	1个M32插头可剪断
cable nominal cross-section area(mm ²)	1.5-2.5	4-6

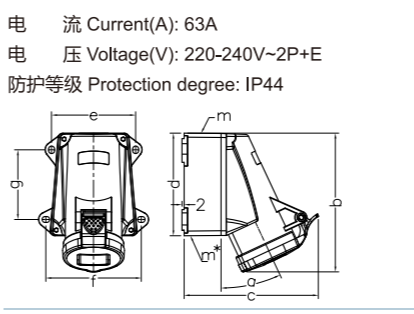

earth contact position	4h	
rated current(A)	63	
	pole 3	
dimension(mm)	a	25°
	b	216
	c	165
	d	171
	e	108
	f	136
	g	133
	M	M40
M*	1个M40插头可剪断	
cable nominal cross-section area(mm ²)	10-16	

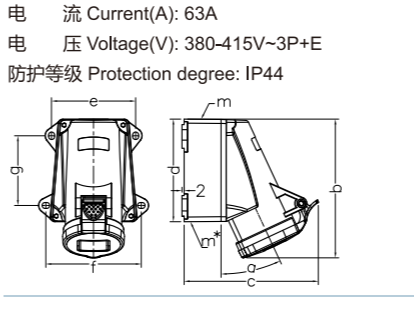

earth contact position	6h	
rated current(A)	63	
	pole 3	
dimension(mm)	a	25°
	b	216
	c	165
	d	171
	e	108
	f	136
	g	133
	M	M40
M*	1个M40插头可剪断	
cable nominal cross-section area(mm ²)	10-16	

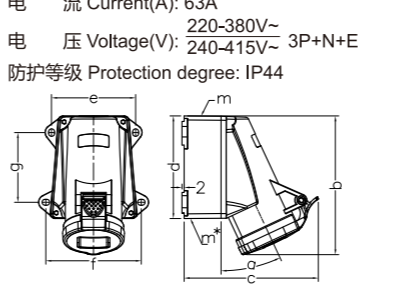

earth contact position	6h	
rated current(A)	63	
	pole 4	
dimension(mm)	a	25°
	b	216
	c	165
	d	171
	e	108
	f	136
	g	133
	M	M40
M*	1个M40插头可剪断	
cable nominal cross-section area(mm ²)	10-16	



earth contact position	6h	
rated current(A)	63	
	pole 5	
dimension(mm)	a	25°
	b	216
	c	165
	d	171
	e	108
	f	136
	g	133
	M	M40
M*	1个M40插头可剪断	
cable nominal cross-section area(mm ²)	10-16	



earth contact position	4h	
rated current(A)	16	32
pole	3	
a	25°	25°
b	127.9	160.2
c	123.7	142.7
d	94.6	120.7
e	77.5	79
f	88	98.5
g	64.2	90.2
M	M25	M32
M*	1个M25插头可剪断	1个M32插头可剪断
cable nominal cross-section area(mm ²)	1.5-2.5	4-6

电 流 Current(A): 16A, 32A
电 压 Voltage(V): 110-130V~2P+E
防护等级 Protection degree: IP67

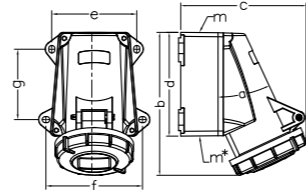

SFK-1193 SFK-1201



earth contact position	6h	
rated current(A)	16	32
pole	3	
a	25°	25°
b	127.9	160.2
c	123.7	142.7
d	94.6	120.7
e	77.5	79
f	88	98.5
g	64.2	90.2
M	M25	M32
M*	1个M25插头可剪断	1个M32插头可剪断
cable nominal cross-section area(mm ²)	1.5-2.5	4-6

电 流 Current(A): 16A, 32A
电 压 Voltage(V): 220-240V~2P+E
防护等级 Protection degree: IP67

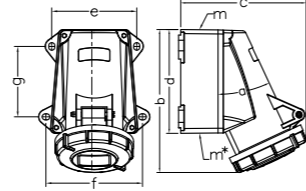

SFK-1192 SFK-1202



earth contact position	6h	
rated current(A)	16	32
pole	4	
a	25°	25°
b	129.9	160.2
c	128.7	142.7
d	94.6	120.7
e	77.5	79
f	88	98.5
g	64.2	90.2
M	M25	M32
M*	1个M25插头可剪断	1个M32插头可剪断
cable nominal cross-section area(mm ²)	1.5-2.5	4-6

电 流 Current(A): 16A, 32A
电 压 Voltage(V): 380-415V~3P+E
防护等级 Protection degree: IP67

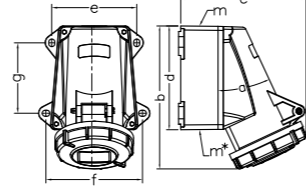

SFK-1196 SFK-1206



earth contact position	6h	
rated current(A)	16	32
pole	5	
a	25°	25°
b	135.4	161.1
c	128.8	149.9
d	94.6	120.7
e	77.5	79
f	88	98.5
g	64.2	90.2
M	M25	M32
M*	1个M25插头可剪断	1个M32插头可剪断
cable nominal cross-section area(mm ²)	1.5-2.5	4-6

电 流 Current(A): 16A, 32A
电 压 Voltage(V): 220-380V~220-380V~3P+N+E
防护等级 Protection degree: IP67

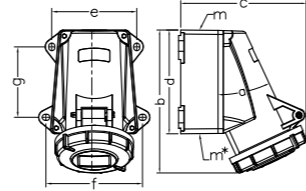

SFK-1200 SFK-1210



earth contact position	4h	
rated current(A)	63	
pole	3	
a	25°	25°
b	216	313
c	169	203
d	171	264
e	108	140
f	136	163
g	133	240
M	M40	M50
M*	1个M40插头可剪断	
cable nominal cross-section area(mm ²)	10-16	

电 流 Current(A): 63A, 125A
电 压 Voltage(V): 110-130V~2P+E
防护等级 Protection degree: IP67

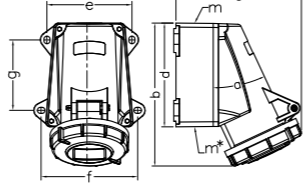

SFK-856



earth contact position	6h	
rated current(A)	63	125
pole	3	
a	25°	25°
b	216	313
c	169	203
d	171	264
e	108	140
f	136	163
g	133	240
M	M40	M50
M*	1个M40插头可剪断	1个M50插头可剪断
cable nominal cross-section area(mm ²)	10-16	25-35

电 流 Current(A): 63A, 125A
电 压 Voltage(V): 220-240V~2P+E
防护等级 Protection degree: IP67

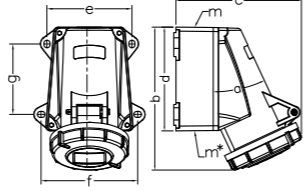

SFK-128 SFK-1381

电 流 Current(A): 63A, 125A
电 压 Voltage(V): 380-415V~3P+E
防护等级 Protection degree: IP67

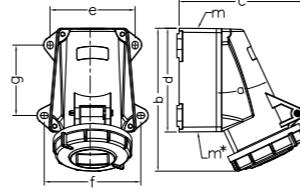

earth contact position	6h	
rated current(A)	63	125
pole	4	
a	25°	25°
b	216	313
c	169	203
d	171	264
e	108	140
f	136	163
g	133	240
M	M40	M50
M*	1个M40插头可剪断	1个M50插头可剪断
cable nominal cross-section area(mm ²)	10-16	25-35



SFK-132 SFK-139

电 流 Current(A): 63A, 125A
电 压 Voltage(V): 220-380V~220-380V~3P+N+E
防护等级 Protection degree: IP67

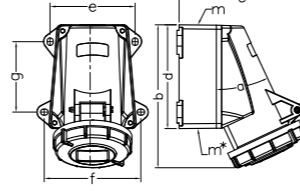

earth contact position	6h	
rated current(A)	63	125
pole	5	
a	25°	25°
b	216	313
c	169	203
d	171	264
e	108	140
f	136	163
g	133	240
M	M40	M50
M*	1个M40插头可剪断	1个M50插头可剪断
cable nominal cross-section area(mm ²)	10-16	25-35



SFK-136 SFK-143

电 流 Current(A): 16A, 32A
电 压 Voltage(V): 110-130V~2P+E
防护等级 Protection degree: IP44

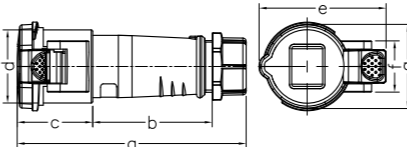

earth contact position	4h	
rated current(A)	16	32
pole	3	
a	155	195.9
b	81	102.7
c	51.1	64.2
d	49.5	64.2
e	86	101.8
f	34.7	37
g	57	71.2
cable nominal cross-section area(mm ²)	1.5-2.5	4-6

CE/IEC国际标准 连接器

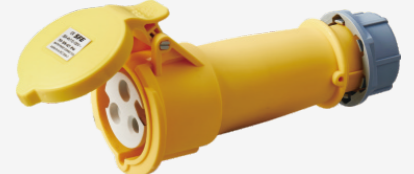

SFK-509 SFK-521

电 流 Current(A): 16A, 32A
电 压 Voltage(V): 220-240V~2P+E
防护等级 Protection degree: IP44

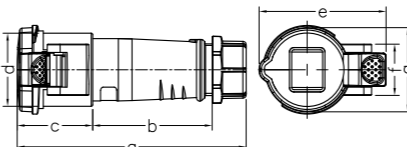

earth contact position	6h	
rated current(A)	16	32
pole	3	
a	155	195.9
b	81	102.7
c	51.1	64.2
d	49.5	64.2
e	86	101.8
f	34.7	37
g	57	71.2
cable nominal cross-section area(mm ²)	1.5-2.5	4-6



SFK-510 SFK-522

电 流 Current(A): 16A, 32A
电 压 Voltage(V): 380-415V~3P+E
防护等级 Protection degree: IP44

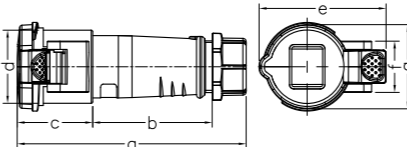

earth contact position	6h	
rated current(A)	16	32
pole	4	
a	155	195.9
b	81	102.7
c	51.2	64.2
d	55.7	64.2
e	90.4	101.8
f	37	37
g	61.2	71.2
cable nominal cross-section area(mm ²)	1.5-2.5	4-6



SFK-514 SFK-526

电 流 Current(A): 16A, 32A
电 压 Voltage(V): 220-380V~220-380V~3P+N+E
防护等级 Protection degree: IP44

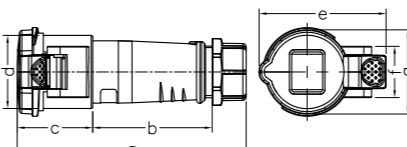

earth contact position	6h	
rated current(A)	16	32
pole	5	
a	160	195
b	86	103.2
c	51	62.8
d	63	70.8
e	97.2	104.9
f	37	37
g	74.5	80
cable nominal cross-section area(mm ²)	1.5-2.5	4-6



SFK-5 SFK-6

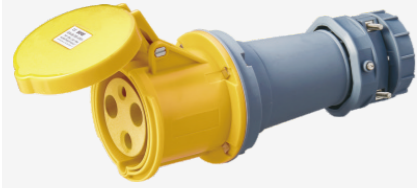

SFK-1236

earth contact position	4h
rated current(A)	63
pole	3
a	257
b	112.5
c	85
d	77.4
e	108
f	34
g	92
cable nominal cross-section area(mm ²)	10-16

电 流 Current(A): 63A
电 压 Voltage(V): 110-130V~2P+E
防护等级 Protection degree: IP44

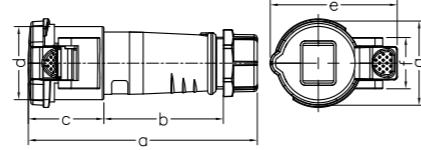

电 流 Current(A): 16A, 32A
电 压 Voltage(V): 380-415V~3P+E
防护等级 Protection degree: IP67

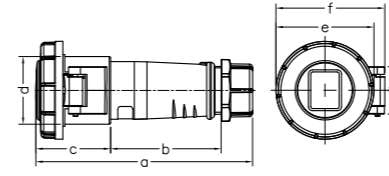

earth contact position	6h
rated current(A)	16 32
pole	4
a	158.5 199.2
b	80.6 102.7
c	54.9 67.5
d	55.7 64.2
e	80.6 95.5
f	85.2 98.7
g	37 37
cable nominal cross-section area(mm ²)	1.5-2.5 4-6



SFK-544 SFK-556

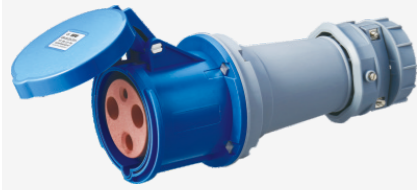

SFK-1237

earth contact position	6h
rated current(A)	63
pole	3
a	257
b	112.5
c	85
d	77.4
e	108
f	34
g	92
cable nominal cross-section area(mm ²)	10-16

电 流 Current(A): 63A
电 压 Voltage(V): 220-240V~2P+E
防护等级 Protection degree: IP44

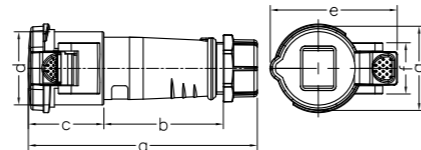

电 流 Current(A): 16A, 32A
电 压 Voltage(V): 220-380V~240-415V~3P+N+E
防护等级 Protection degree: IP67

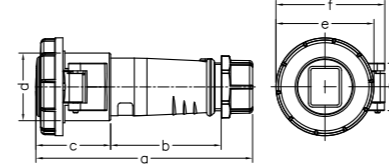

earth contact position	6h
rated current(A)	16 32
pole	5
a	142 200
b	119 103.2
c	56 67.8
d	63 70.8
e	89 102
f	92.8 104.9
g	37 37
cable nominal cross-section area(mm ²)	1.5-2.5 4-6



SFK-550 SFK-562

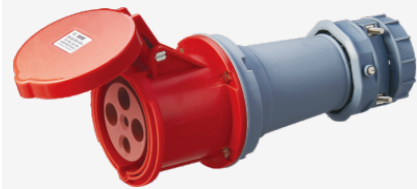

SFK-1241

earth contact position	6h
rated current(A)	63
pole	4
a	257
b	112.5
c	85
d	77.4
e	108
f	34
g	92
cable nominal cross-section area(mm ²)	10-16

电 流 Current(A): 63A
电 压 Voltage(V): 380-415V~3P+E
防护等级 Protection degree: IP44

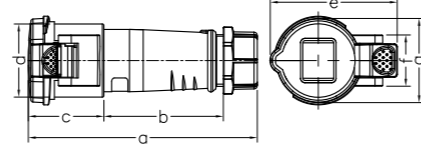

电 流 Current(A): 63A, 125A
电 压 Voltage(V): 110-130V~2P+E
防护等级 Protection degree: IP67

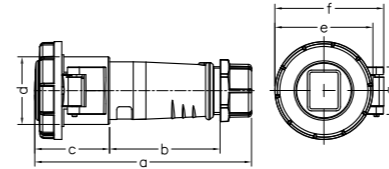

earth contact position	4h
rated current(A)	63 125
pole	3
a	260 300
b	104 140
c	95.8 100
d	77.4 89.5
e	112.5 123
f	109 121
g	34 34.5
cable nominal cross-section area(mm ²)	10-16 25-35

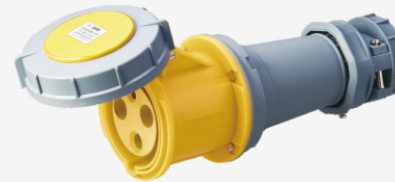

SFK-1573 SFK-3389

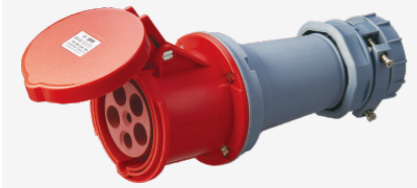

SFK-1245

earth contact position	6h
rated current(A)	63
pole	5
a	257
b	112.5
c	85
d	77.4
e	108
f	34
g	92
cable nominal cross-section area(mm ²)	10-16

电 流 Current(A): 63A
电 压 Voltage(V): 220-380V~240-415V~3P+N+E
防护等级 Protection degree: IP44

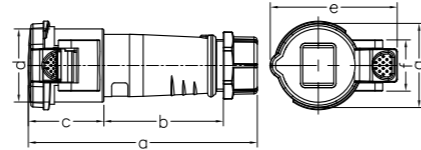

电 流 Current(A): 63A, 125A
电 压 Voltage(V): 220-240V~2P+E
防护等级 Protection degree: IP67

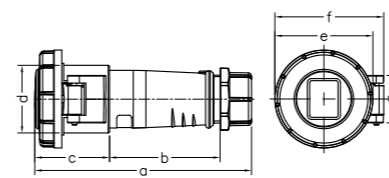

earth contact position	6h
rated current(A)	63 125
pole	3
a	260 300
b	104 140
c	95.8 100
d	77.4 89.5
e	112.5 123
f	109 121
g	34 34.5
cable nominal cross-section area(mm ²)	10-16 25-35



SFK-1574 SFK-3390

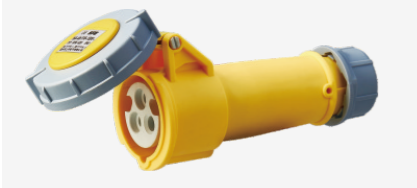

SFK-539 SFK-551

earth contact position	4h
rated current(A)	16 32
pole	3
a	158.6 199.2
b	81 102.7
c	54.7 67.5
d	49.5 64.2
e	71.7 95.5
f	79.6 98.7
g	34.7 37
cable nominal cross-section area(mm ²)	1.5-2.5 4-6

电 流 Current(A): 16A, 32A
电 压 Voltage(V): 110-130V~2P+E
防护等级 Protection degree: IP67

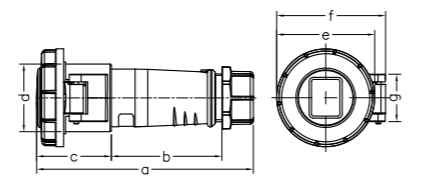

电 流 Current(A): 63A, 125A
电 压 Voltage(V): 380-415V~3P+E
防护等级 Protection degree: IP67

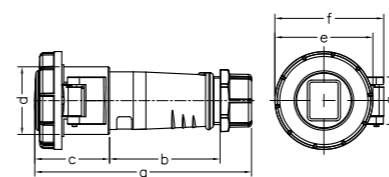

earth contact position	6h
rated current(A)	63 125
pole	4
a	260 300
b	104 140
c	95.8 100
d	77.4 89.5
e	112.5 123
f	109 121
g	34 34.5
cable nominal cross-section area(mm ²)	10-16 25-35

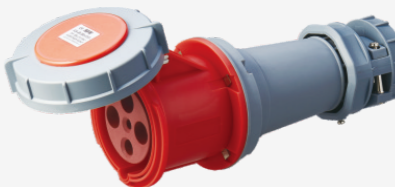

SFK-1117 SFK-1450



SFK-540 SFK-552

earth contact position	6h
rated current(A)	16 32
pole	3
a	158.6 199.2
b	81 102.7
c	54.7 67.5
d	49.5 64.2
e	71.7 95.5
f	79.6 98.7
g	34.7 37
cable nominal cross-section area(mm ²)	1.5-2.5 4-6

电 流 Current(A): 16A, 32A
电 压 Voltage(V): 220-240V~2P+E
防护等级 Protection degree: IP67

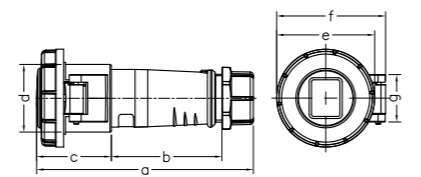

电 流 Current(A): 63A, 125A
电 压 Voltage(V): 220-380V~240-415V~3P+N+E
防护等级 Protection degree: IP67

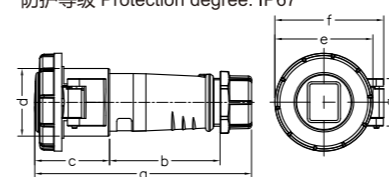

earth contact position	6h
rated current(A)	63 125
pole	5
a	260 300
b	104 140
c	95.8 100
d	77.4 89.5
e	112.5 123
f	109 121
g	34 34.5
cable nominal cross-section area(mm ²)	10-16 25-35

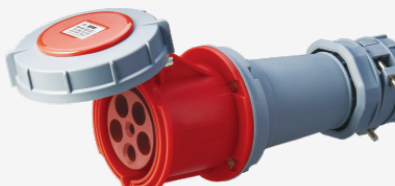

SFK-1121 SFK-1454

CE/IEC国际标准 暗装插座
符合欧洲/国际标准 EN/IEC 60309-2

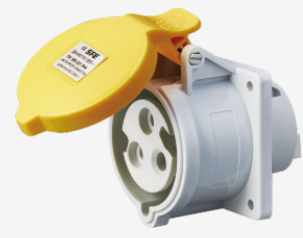

SFK-1365 SFK-1394

earth contact position	4h	
rated current(A)	16	32
pole	3	
a	75	75
b	75	75
c	60	60
d	60	60
e	5.5	5.5
f	31.8	40.8
g	8	8
g1	2	2
h	91	101.8
i	45	58
j	51.2	63
cable nominal cross-section area(mm ²)	1.5-2.5	4-6

电 流 Current(A): 16A, 32A
电 压 Voltage(V): 110-130V~2P+E
防护等级 Protection degree: IP44

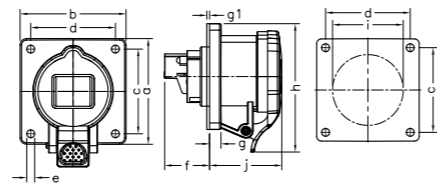

电 流 Current(A): 63A
电 压 Voltage(V): 380-415V~3P+E
防护等级 Protection degree: IP44

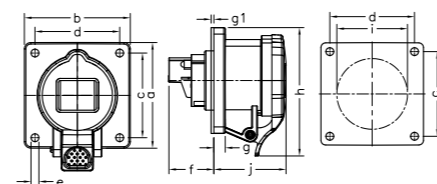

earth contact position	6h	
rated current(A)	63	
pole	4	
a	107	107
b	100	100
c	86	86
d	78	78
e	6	6
f	55	55
g	12	12
g1	2	2
h	113	113
i	89	89
j	80	80
cable nominal cross-section area(mm ²)	10-16	



SFK-1248



SFK-1366 SFK-1395

earth contact position	6h	
rated current(A)	16	32
pole	3	
a	75	75
b	75	75
c	60	60
d	60	60
e	5.5	5.5
f	31.8	40.8
g	8	8
g1	2	2
h	91	101.8
i	45	58
j	51.2	63
cable nominal cross-section area(mm ²)	1.5-2.5	4-6

电 流 Current(A): 16A, 32A
电 压 Voltage(V): 220-240V~2P+E
防护等级 Protection degree: IP44

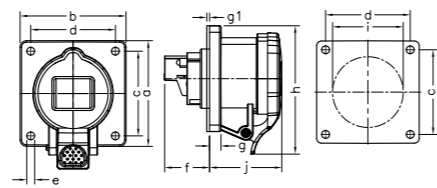

电 流 Current(A): 63A
电 压 Voltage(V): 220-380V~
240-415V~ 3P+N+E
防护等级 Protection degree: IP44

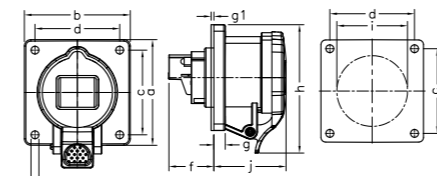

earth contact position	6h	
rated current(A)	63	
pole	5	
a	107	107
b	100	100
c	86	86
d	78	78
e	6	6
f	55	55
g	12	12
g1	2	2
h	113	113
i	89	89
j	80	80
cable nominal cross-section area(mm ²)	10-16	



SFK-1252



SFK-1390 SFK-1399

earth contact position	6h	
rated current(A)	16	32
pole	4	
a	75	75
b	75	75
c	60	60
d	60	60
e	5.5	5.5
f	32.2	40.8
g	8	8
g1	2	2
h	92.4	101.8
i	52	58
j	51.1	63
cable nominal cross-section area(mm ²)	1.5-2.5	4-6

电 流 Current(A): 16A, 32A
电 压 Voltage(V): 380-415V~3P+E
防护等级 Protection degree: IP44

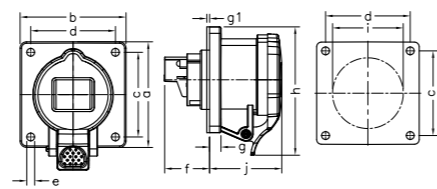

电 流 Current(A): 16A, 32A
电 压 Voltage(V): 110-130V~2P+E
防护等级 Protection degree: IP67

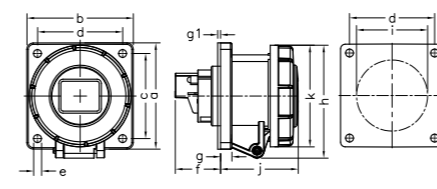

earth contact position	4h	
rated current(A)	16	32
pole	3	
a	75	75
b	75	75
c	60	60
d	60	60
e	5.5	5.5
f	31.8	40.8
g	8	8
g1	2	2
h	79.6	107.7
i	45	58
j	54.8	66.3
k	71.7	95.5
cable nominal cross-section area(mm ²)	1.5-2.5	4-6



SFK-217 SFK-229



SFK-1385 SFK-3451

earth contact position	6h	
rated current(A)	16	32
pole	5	
a	75	75
b	75	75
c	60	60
d	60	60
e	5.5	5.5
f	31.1	39.8
g	8	8
g1	2	2
h	97.2	111.7
i	55	62
j	52.7	62.2
cable nominal cross-section area(mm ²)	1.5-2.5	4-6

电 流 Current(A): 16A, 32A
电 压 Voltage(V): 220-380V~
240-415V~ 3P+N+E
防护等级 Protection degree: IP44

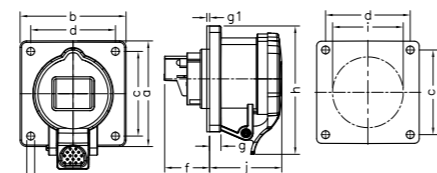

电 流 Current(A): 16A, 32A
电 压 Voltage(V): 220-240V~2P+E
防护等级 Protection degree: IP67

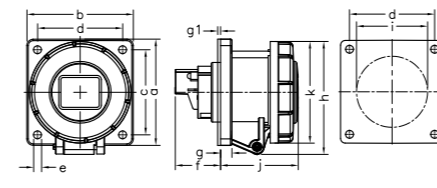

earth contact position	6h	
rated current(A)	16	32
pole	3	
a	75	75
b	75	75
c	60	60
d	60	60
e	5.5	5.5
f	31.8	40.8
g	8	8
g1	2	2
h	79.6	107.7
i	45	58
j	54.8	66.3
k	71.7	95.5
cable nominal cross-section area(mm ²)	1.5-2.5	4-6



SFK-218 SFK-230



SFK-1260

earth contact position	4h	
rated current(A)	63	
pole	3	
a	107	107
b	100	100
c	86	86
d	78	78
e	6	6
f	55	55
g	12	12
g1	2	2
h	113	113
i	89	89
j	80	80
cable nominal cross-section area(mm ²)	10-16	

电 流 Current(A): 63A
电 压 Voltage(V): 110-130V~2P+E
防护等级 Protection degree: IP44

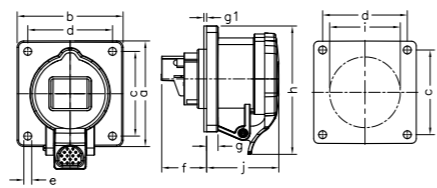

电 流 Current(A): 16A, 32A
电 压 Voltage(V): 380-415V~3P+E
防护等级 Protection degree: IP67

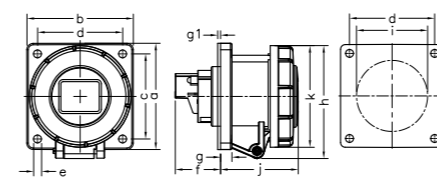

earth contact position	6h	
rated current(A)	16	32
pole	4	
a	75	75
b	75	75
c	60	60
d	60	60
e	5.5	5.5
f	32.2	40.8
g	8	8
g1	2	2
h	85.3	107.7
i	52	58
j	54.6	66.3
k	80.6	95.5
cable nominal cross-section area(mm ²)	1.5-2.5	4-6



SFK-222 SFK-234



SFK-1261

earth contact position	6h	
rated current(A)	63	
pole	3	
a	107	107
b	100	100
c	86	86
d	78	78
e	6	6
f	55	55
g	12	12
g1	2	2
h	113	113
i	89	89
j	80	80
cable nominal cross-section area(mm ²)	10-16	

电 流 Current(A): 63A
电 压 Voltage(V): 220-240V~2P+E
防护等级 Protection degree: IP44

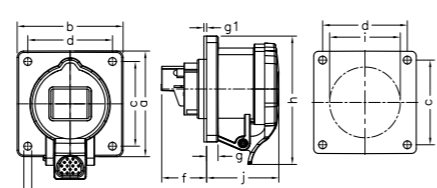

电 流 Current(A): 16A, 32A
电 压 Voltage(V): 220-380V~
240-415V~ 3P+N+E
防护等级 Protection degree: IP67

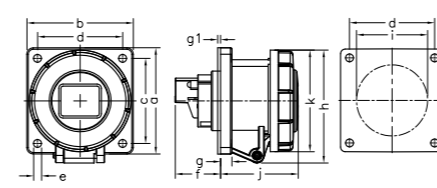

earth contact position	6h	
rated current(A)	16	32
pole	5	
a	75	75
b	75	75
c	60	60
d	60	60
e	5.5	5.5
f	32.2	39.8
g	8	8
g1	2	2
h	92.9	106
i	55	62
j	58.5	67.9
k	89	102
cable nominal cross-section area(mm ²)	1.5-2.5	4-6



SFK-228 SFK-240



earth contact position	4h	
rated current(A)	63	125
pole	3	
a	107	130
b	100	130
c	86	104
d	78	104
e	6.5	6.5
f	55	43
g	12	18
g1	2	2
h	113	122
i	89	95
j	84	124
k	118	135
cable nominal cross-section area(mm²)	10-16	25-35

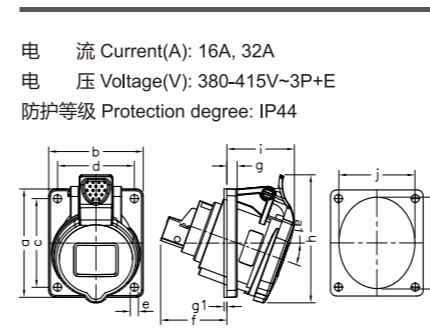
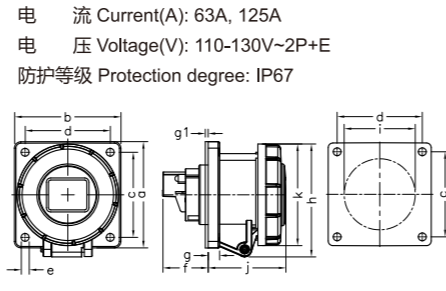

earth contact position	6h	
rated current(A)	16	32
pole	4	
a1	20°	20°
a	85	85
b	85	85
c	70	70
d	70	70
e	5.5	5.5
f	40.3	54.3
g	8	8
g1	2	2
h	92.4	98.7
i	51.5	57.9
j	58	68
k	65	80
cable nominal cross-section area(mm²)	1.5-2.5	4-6

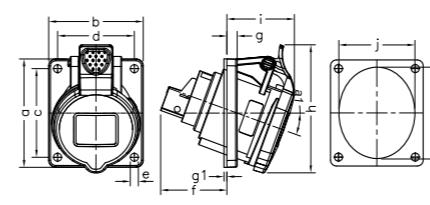

earth contact position	6h	
rated current(A)	16	32
pole	5	
a1	20°	20°
a	85	85
b	85	85
c	70	70
d	70	70
e	5.5	5.5
f	41.6	55.5
g	8	8
g1	2	2
h	97.2	111.2
i	51.9	58.2
j	67	73
k	72	84
cable nominal cross-section area(mm²)	1.5-2.5	4-6

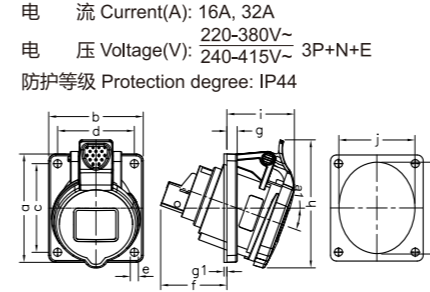

earth contact position	6h	
rated current(A)	63	125
pole	3	
a	107	130
b	100	130
c	86	104
d	78	104
e	6.5	6.5
f	55	43
g	12	18
g1	2	2
h	113	122
i	89	95
j	84	124
k	118	135
cable nominal cross-section area(mm²)	10-16	25-35

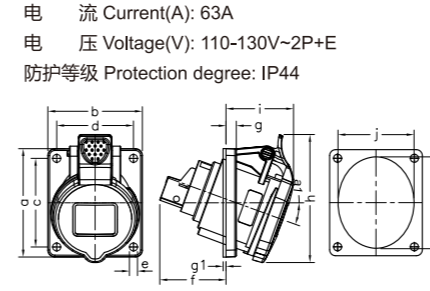
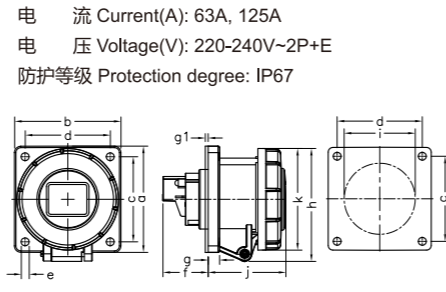

earth contact position	4h	
rated current(A)	63	125
pole	3	
a1	20°	110
a	106	106
b	85	85
c	77	77
d	6.2	6.2
e	69	69
f	12	12
g	2	2
g1	122	122
h	85	85
i	70	70
j	95	95
k	10-16	10-16

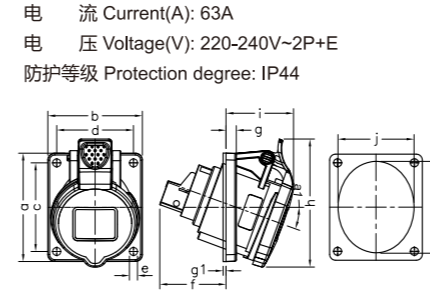

earth contact position	6h	
rated current(A)	63	125
pole	4	
a	107	130
b	100	130
c	86	104
d	78	104
e	6.5	6.5
f	55	43
g	12	18
g1	2	2
h	113	122
i	89	95
j	84	124
k	118	135
cable nominal cross-section area(mm²)	10-16	25-35

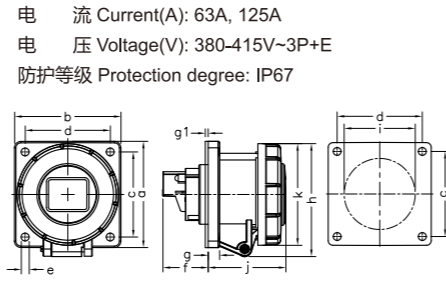

earth contact position	6h	
rated current(A)	63	125
pole	5	
a	107	130
b	100	130
c	86	104
d	78	104
e	6.5	6.5
f	55	43
g	12	18
g1	2	2
h	113	122
i	89	95
j	84	124
k	118	135
cable nominal cross-section area(mm²)	10-16	25-35

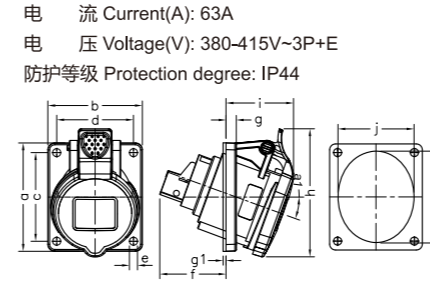
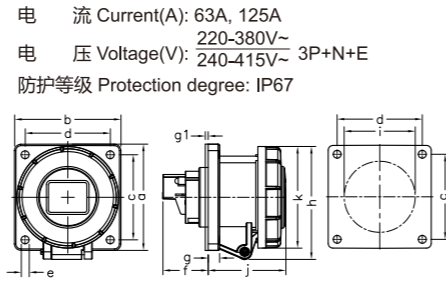

earth contact position	6h	
rated current(A)	63	125
pole	3	
a1	20°	20°
a	73.5	85
b	64	85
c	60	70
d	52	70
e	5.5	5.5
f	44.9	54.3
g	7	8
g1	2	2
h	86.7	98.7
i	45.7	57.9
j	52	68
k	61	80
cable nominal cross-section area(mm²)	1.5-2.5	4-6

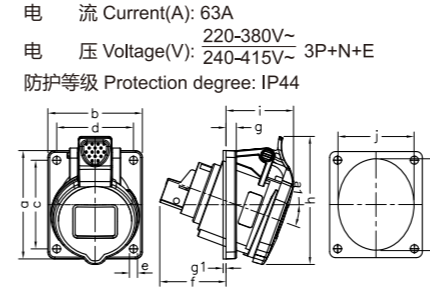

earth contact position	4h	
rated current(A)	16	32
pole	3	
a1	20°	20°
a	73.5	85
b	64	85
c	60	70
d	52	70
e	5.5	5.5
f	44.9	54.3
g	7	8
g1	2	2
h	86.7	98.7
i	45.7	57.9
j	52	68
k	61	80
cable nominal cross-section area(mm²)	1.5-2.5	4-6

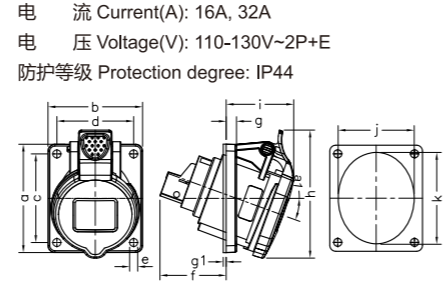

earth contact position	6h	
rated current(A)	16	32
pole	3	
a1	20°	20°
a	73.5	85
b	64	85
c	60	70
d	52	70
e	5.5	5.5
f	44.9	54.3
g	7	8
g1	2	2
h	86.7	98.7
i	45.7	57.9
j	52	68
k	61	80
cable nominal cross-section area(mm²)	1.5-2.5	4-6

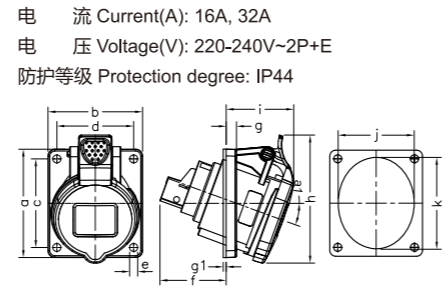

earth contact position	6h	
rated current(A)	63	125
pole	5	
a1	20°	20°
a	110	110
b	106	106
c	85	85
d	77	77
e	6.2	6.2
f	69	69
g	12	12
g1	2	2
h	122	122
i	85	85
j	70	70
k	95	95
cable nominal cross-section area(mm²)	10-16	10-16

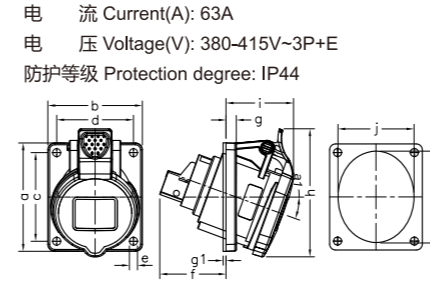



SFK-1474 SFK-1501

earth contact position	4h	
rated current(A)	16	32
pole	3	
a1	20°	20°
a	73.5	73.5
b	64	64
c	60	60
d	52	52
e	5.5	5.5
f	42.9	55.5
g	7	8
g1	2	2
h	82.6	108.9
i	51.7	63.2
j	52	68
k	61	80
cable nominal cross-section area(mm ²)	1.5-2.5	4-6

电 流 Current(A): 16A, 32A
电 压 Voltage(V): 110-130V~2P+E
防护等级 Protection degree: IP67

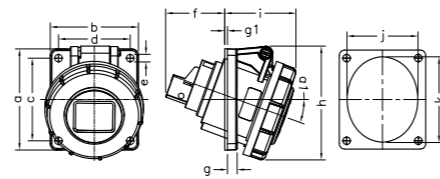

SFK-1475 SFK-1502

earth contact position	6h	
rated current(A)	16	32
pole	3	
a1	20°	20°
a	73.5	73.5
b	64	64
c	60	60
d	52	52
e	5.5	5.5
f	42.9	55.5
g	7	8
g1	2	2
h	82.6	108.9
i	51.7	63.2
j	52	68
k	61	80
cable nominal cross-section area(mm ²)	1.5-2.5	4-6

电 流 Current(A): 16A, 32A
电 压 Voltage(V): 220-240V~2P+E
防护等级 Protection degree: IP67

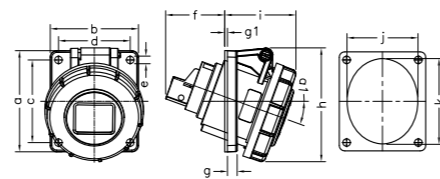

SFK-1479 SFK-1506

earth contact position	6h	
rated current(A)	16	32
pole	4	
a1	20°	20°
a	85	85
b	85	85
c	70	70
d	70	70
e	5.5	5.5
f	40.3	55.5
g	8	8
g1	2	2
h	88.6	108.9
i	56.2	63.2
j	58	68
k	65	80
cable nominal cross-section area(mm ²)	1.5-2.5	4-6

电 流 Current(A): 16A, 32A
电 压 Voltage(V): 380-415V~3P+E
防护等级 Protection degree: IP67

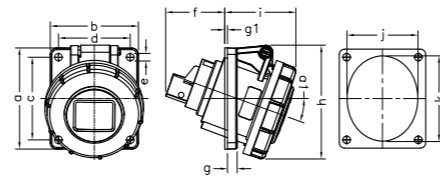

SFK-1485 SFK-1551

earth contact position	6h	
rated current(A)	16	32
pole	5	
a1	20°	20°
a	85	85
b	85	85
c	70	70
d	70	70
e	5.5	5.5
f	41.6	55.5
g	8	8
g1	2	2
h	96	109
i	58.6	63.2
j	67	73
k	72	84
cable nominal cross-section area(mm ²)	1.5-2.5	4-6

电 流 Current(A): 16A, 32A
电 压 Voltage(V): 220-380V~
240-415V~ 3P+N+E
防护等级 Protection degree: IP67

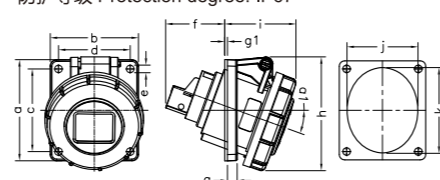

SFK-2179

earth contact position	4h	
rated current(A)	63	125
pole	3	
a1	20°	20°
a	110	110
b	106	110
c	85	90
d	85	90
e	6.2	6.2
f	46	47
g	12	13
g1	2	2
h	125	135
i	85	85
j	69	103
k	117	135
cable nominal cross-section area(mm ²)	10-16	25-35

电 流 Current(A): 63A, 125A
电 压 Voltage(V): 110-130V~2P+E
防护等级 Protection degree: IP67

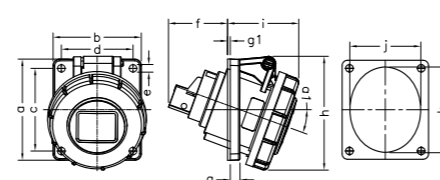

SFK-2180 SFK-3575

earth contact position	6h	
rated current(A)	63	125
pole	3	
a1	20°	20°
a	110	114
b	106	110
c	85	90
d	77	90
e	6.2	6.2
f	46	47
g	12	13
g1	2	2
h	125	135
i	85	85
j	69	103
k	117	135
cable nominal cross-section area(mm ²)	10-16	25-35

电 流 Current(A): 63A, 125A
电 压 Voltage(V): 220-240V~2P+E
防护等级 Protection degree: IP67

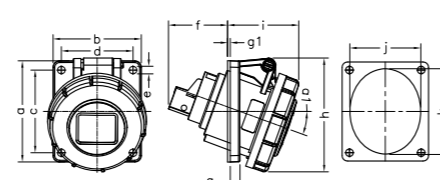

电 流 Current(A): 63A, 125A
电 压 Voltage(V): 380-415V~3P+E
防护等级 Protection degree: IP67

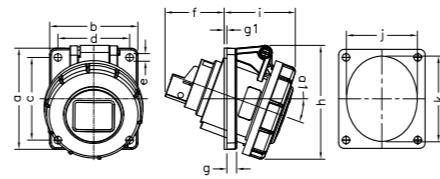

earth contact position	6h	
rated current(A)	63	125
pole	4	
a1	20°	20°
a	110	114
b	106	110
c	85	90
d	77	90
e	6.2	6.2
f	46	47
g	12	13
g1	2	2
h	125	135
i	85	85
j	69	103
k	117	135
cable nominal cross-section area(mm ²)	10-16	25-35



SFK-205 SFK-212

电 流 Current(A): 63A, 125A
电 压 Voltage(V): 220-380V~
240-415V~ 3P+N+E
防护等级 Protection degree: IP67

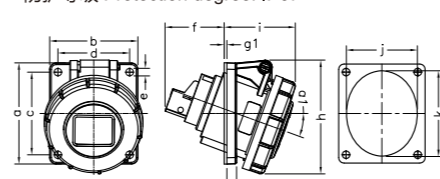

earth contact position	6h	
rated current(A)	63	125
pole	5	
a1	20°	20°
a	110	114
b	106	110
c	85	90
d	77	90
e	6.2	6.2
f	46	47
g	12	13
g1	2	2
h	125	135
i	85	85
j	69	103
k	117	135
cable nominal cross-section area(mm ²)	10-16	25-35



SFK-209 SFK-216

电 流 Current(A): 63A, 125A
电 压 Voltage(V): 220-240V~2P+E
防护等级 Protection degree: IP67

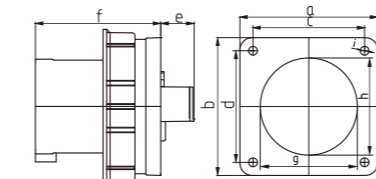

earth contact position	4h	
rated current(A)	63	125
pole	3	
a	100	120
b	100	120
c	80	101
d	80	101
e	13	22
f	99	110
g	73	84
h	73	84
i	6	6
cable nominal cross-section area(mm ²)	6-16	16-50



SFN-6332-4 SFN-6432-4

电 流 Current(A): 63A, 125A
电 压 Voltage(V): 220-240V~2P+E
防护等级 Protection degree: IP67

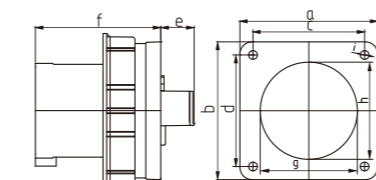

earth contact position	6h	
rated current(A)	63	125
pole	3	
a	100	120
b	100	120
c	80	101
d	80	101
e	13	22
f	99	110
g	73	84
h	73	84
i	6	6
cable nominal cross-section area(mm ²)	6-16	16-50



SFN-6332 SFN-6432

电 流 Current(A): 63A, 125A
电 压 Voltage(V): 380-415V~3P+E
防护等级 Protection degree: IP67

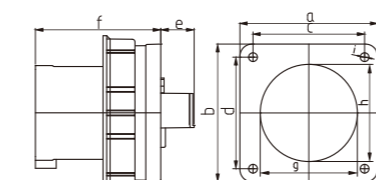

earth contact position	6h	
rated current(A)	63	125
pole	4	
a	100	120
b	100	120
c	80	101
d	80	101
e	13	22
f	99	110
g	73	84
h	73	84
i	6	6
cable nominal cross-section area(mm ²)	6-16	16-50



SFN-6342 SFN-6442

电 流 Current(A): 63A, 125A
电 压 Voltage(V): 220-380V~
240-415V~ 3P+N+E
防护等级 Protection degree: IP67

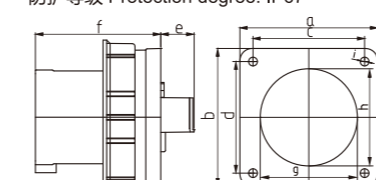

earth contact position	6h	
rated current(A)	63	125
pole	5	
a	100	120
b	100	120
c	80	101
d	80	101
e	13	22
f	99	110
g	73	84
h	73	84
i	6	6
cable nominal cross-section area(mm ²)	6-16	16-50

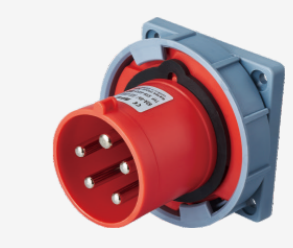

SFN-6352 SFN-6452

CE/IEC国际标准 明装插头
符合欧洲/国际标准 EN/IEC 60309-2

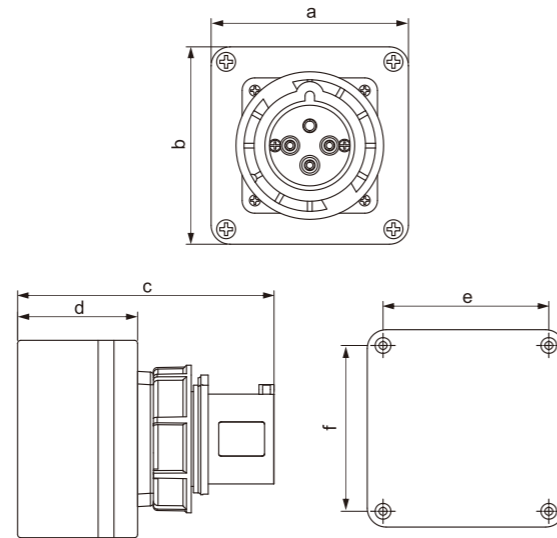

电流	极数	110V 50a.60Hz	230V 50a.60Hz	400V 50a.60Hz	500V 50a.60Hz	>50-500V 100-300Hz	>50-500V a.300-500Hz	包装 单位	重量
		3极 4时 4时	4极 4时 9时	5极 4时 9时	3极 6时 7时	4极 6时 7时	5极 6时 7时		

IP67 CEE/IEC 明装插头

型号

极数	3	4	5	型号	重量
16	3			SFK-5165	430
	4			SFK-5175	436
	5			SFK-5185	467
32	3			SFK-5275	494
	4			SFK-5285	513
	5			SFK-5295	552
63	3			SFK-5525	735
	4			SFK-5535	818
	5			SFK-5545	851

参数

电流	16A			极数	32A			电流	63A			
	3	4	5		3	4	5		3	4	5	
尺寸(mm ²)	a	125	125	125	a	125	125	125	a	125	125	125
	b	125	125	125	b	125	125	125	b	125	125	125
	c	76	76	76	c	76	76	76	c	76	76	76
	d	135	135	135	d	153	153	153	d	149	149	149
	e	105	105	105	e	105	105	105	e	105	105	105
	f	105	105	105	f	105	105	105	f	105	105	105
导线横截面积(mm ²) 从最小至最大	1.5-2.5			导线横截面积(mm ²) 从最小至最大	4-6			导线横截面积(mm ²) 从最小至最大	10-16			

CE/IEC国际标准 插座 带开关和机械联锁
符合欧洲/国际标准 EN/IEC 60309-2

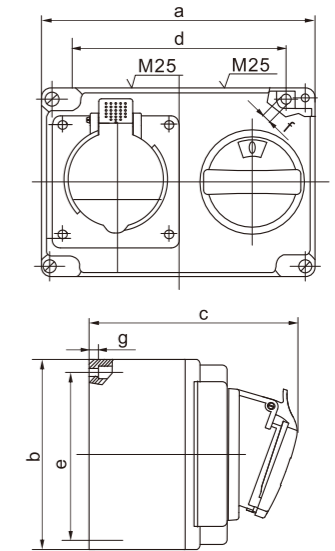

电流	极数	110V 50a.60Hz	230V 50a.60Hz	400V 50a.60Hz	500V 50a.60Hz	>50-500V 100-300Hz	>50-500V a.300-500Hz	包装 单位	重量
		3极 4时 4时	4极 4时 9时	5极 4时 9时	3极 7时 7时	4极 7时 7时	5极 7时 7时		

IP44 CEE/IEC 插座 带开关和机械联锁

型号

极数	3	4	5	型号	重量
16	3			SFK-7273	1010
	4			SFK-7274	1032
				SFK-7275	1064
	5			SFK-7276	

参数

电流	16A			极数
	3	4	5	
尺寸(mm ²)	a	170	170	170
	b	118	118	118
	c	134	137	141
	d	136	136	136
	e	104	104	104
	f	6.1	6.1	6.1
	g	6	6	6
	M	25	25	25
	导线横截面积(mm ²) 从最小至最大	1.5-2.5		

新型工业用插头 New Industrial plug



SFN-013-4 SFN-023-4

earth contact position	4h		
rated current(A)	16	32	
pole	3		
dimension(mm)	a	118	146
	b	82	100
	c	47	63
	d	6-15	10-20
	sw	38	50
cable nominal cross-section area(mm ²)	1-2.5	2.5-6	

电 流 Current(A): 16A. 32A
电 压 Voltage(V): 110-130V~2P+E
防护等级 Protection degree: IP44

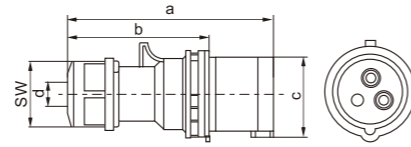

SFN-013 SFN-023

earth contact position	6h		
rated current(A)	16	32	
pole	3		
dimension(mm)	a	118	146
	b	82	100
	c	47	63
	d	6-15	10-20
	sw	38	50
cable nominal cross-section area(mm ²)	1-2.5	2.5-6	

电 流 Current(A): 16A. 32A
电 压 Voltage(V): 220-240V~2P+E
防护等级 Protection degree: IP44

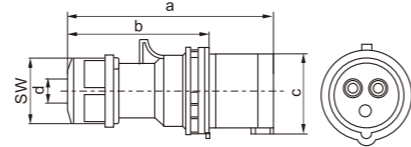

SFN-014 SFN-024

earth contact position	6h		
rated current(A)	16	32	
pole	4		
dimension(mm)	a	124	146
	b	88	100
	c	53	63
	d	6-15	10-20
	sw	38	50
cable nominal cross-section area(mm ²)	1-2.5	2.5-6	

电 流 Current(A): 16A. 32A
电 压 Voltage(V): 380-415V~3P+E
防护等级 Protection degree: IP44

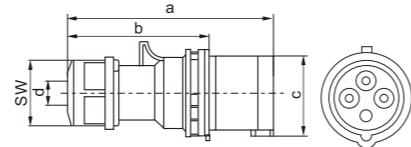

SFN-015 SFN-025

earth contact position	6h		
rated current(A)	16	32	
pole	5		
dimension(mm)	a	131	152
	b	95	106
	c	61	70
	d	8-16	10-20
	sw	42	50
cable nominal cross-section area(mm ²)	1-2.5	2.5-6	

电 流 Current(A): 16A. 32A
电 压 Voltage(V): 220-380V~240-415V~3P+N+E
防护等级 Protection degree: IP44

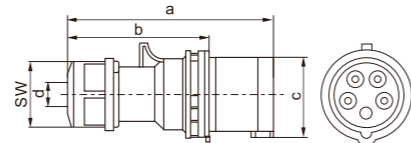

SFN-0132-4 SFN-0232-4

earth contact position	4h		
rated current(A)	16	32	
pole	3		
dimension(mm)	a	118	146
	b	82	100
	c	47	63
	d	6-15	10-20
	sw	38	50
cable nominal cross-section area(mm ²)	1-2.5	2.5-6	

电 流 Current(A): 16A. 32A
电 压 Voltage(V): 110-130V~2P+E
防护等级 Protection degree: IP67

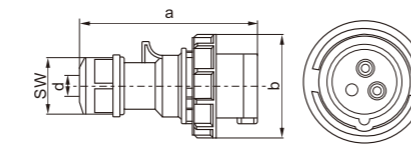

SFN-0132 SFN-0232

earth contact position	6h		
rated current(A)	16	32	
pole	3		
dimension(mm)	a	118	146
	b	82	100
	d	6-15	10-20
	sw	38	50
cable nominal cross-section area(mm ²)	1-2.5	2.5-6	

电 流 Current(A): 16A. 32A
电 压 Voltage(V): 220-240V~3P+E
防护等级 Protection degree: IP67

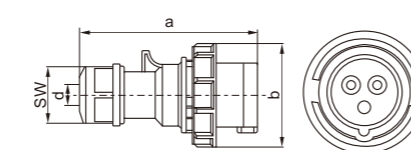

电 流 Current(A): 16A. 32A
电 压 Voltage(V): 380-415V~3P+E
防护等级 Protection degree: IP67

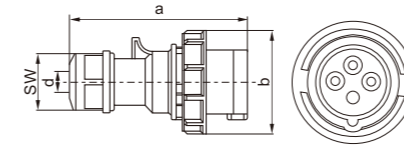

earth contact position	6h		
rated current(A)	16	32	
pole	4		
dimension(mm)	a	124	146
	b	79	93
	d	6-15	10-20
	sw	38	50
cable nominal cross-section area(mm ²)	1-2.5	2.5-6	

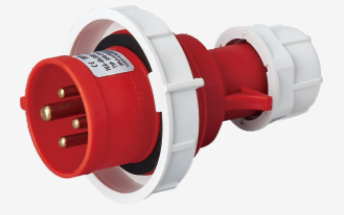

SFN-0142 SFN-0242

电 流 Current(A): 16A. 32A
电 压 Voltage(V): 220-380V~240-415V~3P+N+E
防护等级 Protection degree: IP67

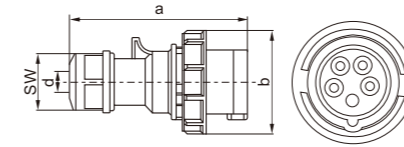

earth contact position	6h		
rated current(A)	16	32	
pole	5		
dimension(mm)	a	131	152
	b	87	100
	d	8-16	10-20
	sw	42	50
cable nominal cross-section area(mm ²)	1-2.5	2.5-6	

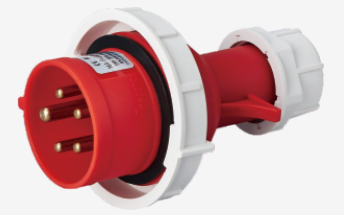

SFN-0152 SFN-0252

电 流 Current(A): 63A. 125A
电 压 Voltage(V): 220-250V~2P+E
防护等级 Protection degree: IP67

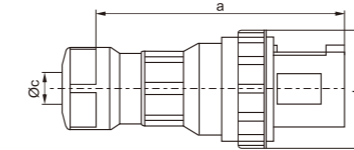

earth contact position	4h		
rated current(A)	63	125	
pole	3		
dimension(mm)	a	240	295
	b	115	126
	c	30	44.5
cable nominal cross-section area(mm ²)	6-16	16-50	

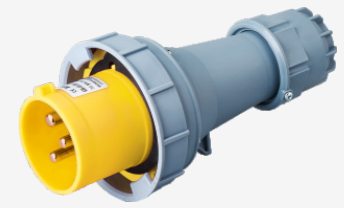

SFN-0332-4 SFN-0432-4

电 流 Current(A): 63A. 125A
电 压 Voltage(V): 220-250V~2P+E
防护等级 Protection degree: IP67

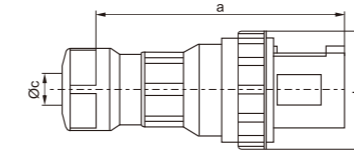

earth contact position	6h		
rated current(A)	63	125	
pole	3		
dimension(mm)	a	240	295
	b	115	126
	c	30	44.5
cable nominal cross-section area(mm ²)	6-16	16-50	

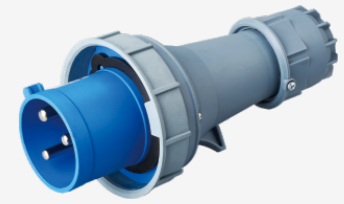

SFN-0332 SFN-0432

电 流 Current(A): 63A. 125A
电 压 Voltage(V): 380-415V~3P+E
防护等级 Protection degree: IP67

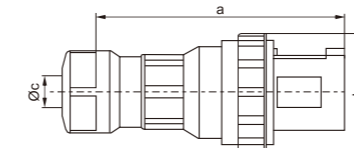

earth contact position	6h		
rated current(A)	63	125	
pole	4		
dimension(mm)	a	240	295
	b	115	126
	c	30	44.5
cable nominal cross-section area(mm ²)	6-16	16-50	

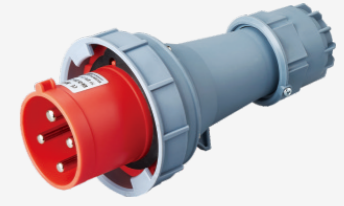

SFN-0342 SFN-0442

电 流 Current(A): 63A. 125A
电 压 Voltage(V): 220-380V~240-415V~3P+N+E
防护等级 Protection degree: IP67

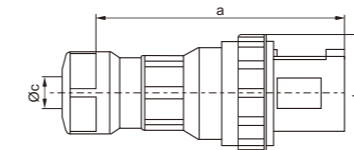

earth contact position	6h		
rated current(A)	63	125	
pole	5		
dimension(mm)	a	240	295
	b	115	126
	c	30	44.5
cable nominal cross-section area(mm ²)	6-16	16-50	

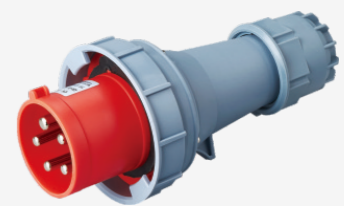

SFN-0352 SFN-0452

新型工业用明装插座 New Industrial socket



SFN-113-4 SFN-123-4

earth contact position	4h	
rated current(A)	16	32
pole	3	
dimension(mm)	a	137 153
	b	87 101
cable nominal cross-section area(mm ²)	1-2.5	2.5-6

电 流 Current(A): 16A. 32A
电 压 Voltage(V): 110-130V~2P+E
防护等级 Protection degree: IP44

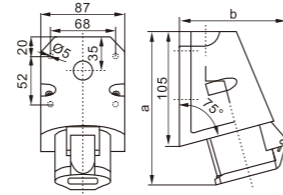

电 流 Current(A): 16A. 32A
电 压 Voltage(V): 380-415V~3P+E
防护等级 Protection degree: IP67

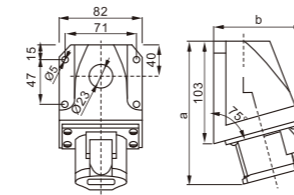

earth contact position	6h	
rated current(A)	16	32
pole	4	
dimension(mm)	a	155 165
	b	98 107
cable nominal cross-section area(mm ²)	1-2.5	2.5-6



SFN-114K SFN-124K



SFN-113 SFN-123

earth contact position	6h	
rated current(A)	16	32
pole	3	
dimension(mm)	a	137 153
	b	87 101
cable nominal cross-section area(mm ²)	1-2.5	2.5-6

电 流 Current(A): 16A. 32A
电 压 Voltage(V): 220-240V~2P+E
防护等级 Protection degree: IP44

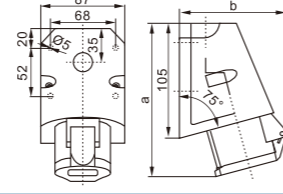

电 流 Current(A): 16A. 32A
电 压 Voltage(V): 220-380V~240-415V~3P+N+E
防护等级 Protection degree: IP67

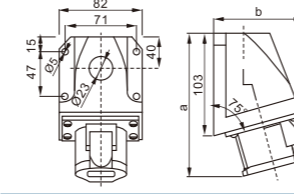

earth contact position	6h	
rated current(A)	16	32
pole	5	
dimension(mm)	a	153 166
	b	103 109
cable nominal cross-section area(mm ²)	1-2.5	2.5-6



SFN-115K SFN-125K



SFN-114 SFN-124

earth contact position	6h	
rated current(A)	16	32
pole	4	
dimension(mm)	a	139 153
	b	95 101
cable nominal cross-section area(mm ²)	1-2.5	2.5-6

电 流 Current(A): 16A. 32A
电 压 Voltage(V): 380-415V~3P+E
防护等级 Protection degree: IP44

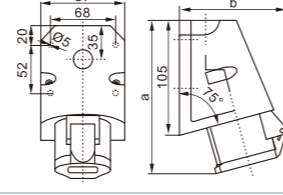

电 流 Current(A): 16A. 32A
电 压 Voltage(V): 110-130V~2P+E
防护等级 Protection degree: IP67

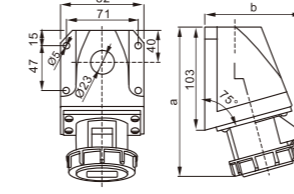

earth contact position	4h	
rated current(A)	16	32
pole	3	
dimension(mm)	a	151 165
	b	96 107
cable nominal cross-section area(mm ²)	1-2.5	2.5-6



SFN-1132-4 SFN-1232-4



SFN-115 SFN-125

earth contact position	6h	
rated current(A)	16	32
pole	5	
dimension(mm)	a	138 154
	b	99 104
cable nominal cross-section area(mm ²)	1-2.5	2.5-6

电 流 Current(A): 16A. 32A
电 压 Voltage(V): 220-380V~240-415V~3P+N+E
防护等级 Protection degree: IP44

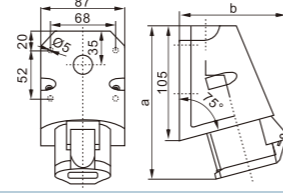

电 流 Current(A): 16A. 32A
电 压 Voltage(V): 220-240V~2P+E
防护等级 Protection degree: IP67

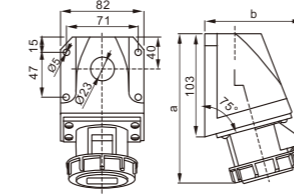

earth contact position	6h	
rated current(A)	16	32
pole	3	
dimension(mm)	a	151 165
	b	96 107
cable nominal cross-section area(mm ²)	1-2.5	2.5-6



SFN-1132 SFN-1232



SFN-113K-4 SFN-123K-4

earth contact position	4h	
rated current(A)	16	32
pole	3	
dimension(mm)	a	151 165
	b	96 107
cable nominal cross-section area(mm ²)	1-2.5	2.5-6

电 流 Current(A): 16A. 32A
电 压 Voltage(V): 110-130V~2P+E
防护等级 Protection degree: IP67

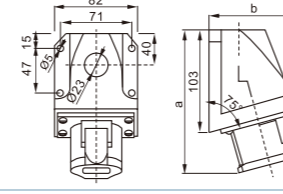

电 流 Current(A): 16A. 32A
电 压 Voltage(V): 380-415V~3P+E
防护等级 Protection degree: IP67

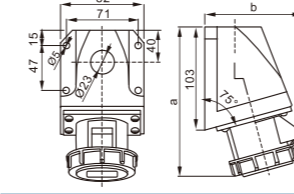

earth contact position	6h	
rated current(A)	16	32
pole	4	
dimension(mm)	a	155 165
	b	98 107
cable nominal cross-section area(mm ²)	1-2.5	2.5-6



SFN-1142 SFN-1242

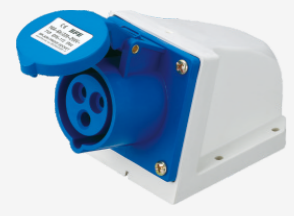

SFN-113K SFN-123K

earth contact position	6h	
rated current(A)	16	32
pole	3	
dimension(mm)	a	151 165
	b	96 107
cable nominal cross-section area(mm ²)	1-2.5	2.5-6

电 流 Current(A): 16A. 32A
电 压 Voltage(V): 220-240V~2P+E
防护等级 Protection degree: IP67

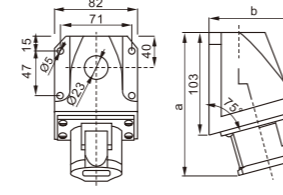

电 流 Current(A): 16A. 32A
电 压 Voltage(V): 220-380V~240-415V~3P+N+E
防护等级 Protection degree: IP67

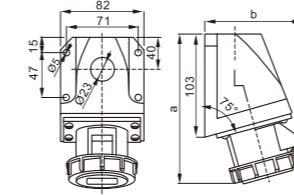

earth contact position	6h	
rated current(A)	16	32
pole	5	
dimension(mm)	a	153 166
	b	103 109
cable nominal cross-section area(mm ²)	1-2.5	2.5-6



SFN-1152 SFN-1252



earth contact position	4h	
rated current(A)	63	125
pole	3	
dimension(mm)	a	175
	b	170
	c	230
	d	118
	e	136
	f	104
cable nominal cross-section area(mm ²)	6-16	16-50

电 流 Current(A): 63A. 125A
电 压 Voltage(V): 220-250V~2P+E
防护等级 Protection degree: IP67

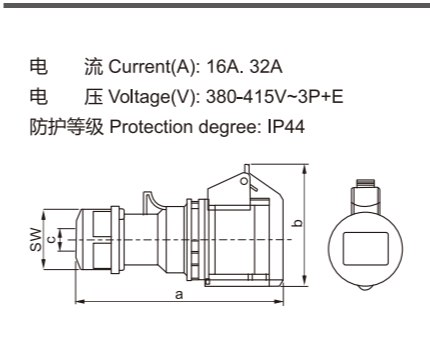
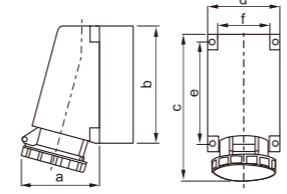

earth contact position	6h	
rated current(A)	16	32
pole	4	
dimension(mm)	a	135
	b	80
	c	6-15
	sw	38
cable nominal cross-section area(mm ²)	1-2.5	2.5-6



earth contact position	6h	
rated current(A)	63	125
pole	3	
dimension(mm)	a	175
	b	170
	c	230
	d	118
	e	136
	f	104
cable nominal cross-section area(mm ²)	6-16	16-50

电 流 Current(A): 63A. 125A
电 压 Voltage(V): 220-250V~2P+E
防护等级 Protection degree: IP67

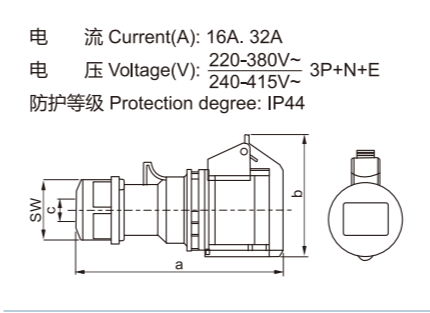
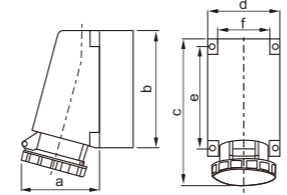

earth contact position	6h	
rated current(A)	16	32
pole	5	
dimension(mm)	a	142
	b	89
	c	8-16
	sw	42
cable nominal cross-section area(mm ²)	1-2.5	2.5-6



earth contact position	6h	
rated current(A)	63	125
pole	4	
dimension(mm)	a	175
	b	170
	c	230
	d	118
	e	136
	f	104
cable nominal cross-section area(mm ²)	6-16	16-50

电 流 Current(A): 63A. 125A
电 压 Voltage(V): 380-415V~3P+E
防护等级 Protection degree: IP67

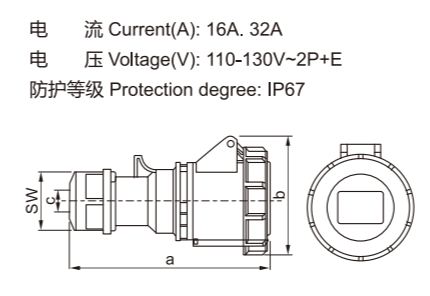
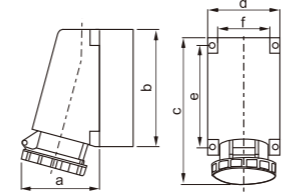

earth contact position	4h	
rated current(A)	16	32
pole	3	
dimension(mm)	a	133
	b	78
	c	6-15
	sw	38
cable nominal cross-section area(mm ²)	1-2.5	2.5-6



earth contact position	6h	
rated current(A)	63	125
pole	5	
dimension(mm)	a	175
	b	170
	c	230
	d	118
	e	136
	f	104
cable nominal cross-section area(mm ²)	6-16	16-50

电 流 Current(A): 63A. 125A
电 压 Voltage(V): 220-380V~240-415V~3P+N+E
防护等级 Protection degree: IP67

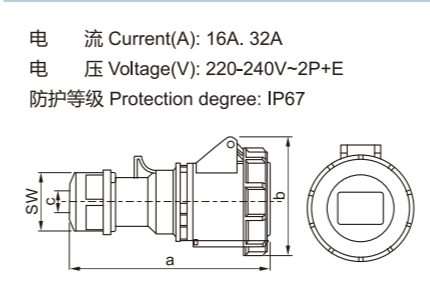
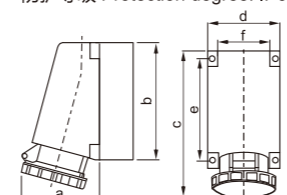

earth contact position	6h	
rated current(A)	16	32
pole	3	
dimension(mm)	a	133
	b	78
	c	6-15
	sw	38
cable nominal cross-section area(mm ²)	1-2.5	2.5-6



earth contact position	4h	
rated current(A)	16	32
pole	3	
dimension(mm)	a	129
	b	76
	c	6-15
	sw	38
cable nominal cross-section area(mm ²)	1-2.5	2.5-6

电 流 Current(A): 16A. 32A
电 压 Voltage(V): 110-130V~2P+E
防护等级 Protection degree: IP44

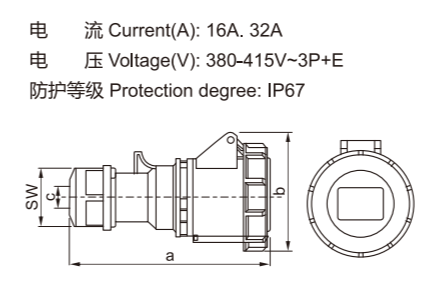
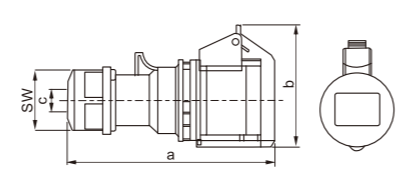

earth contact position	6h	
rated current(A)	16	32
pole	4	
dimension(mm)	a	139
	b	84
	c	6-15
	sw	38
cable nominal cross-section area(mm ²)	1-2.5	2.5-6



earth contact position	6h	
rated current(A)	16	32
pole	3	
dimension(mm)	a	129
	b	76
	c	6-15
	sw	38
cable nominal cross-section area(mm ²)	1-2.5	2.5-6

电 流 Current(A): 16A. 32A
电 压 Voltage(V): 220-240V~2P+E
防护等级 Protection degree: IP44

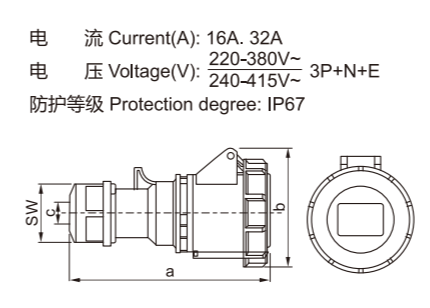
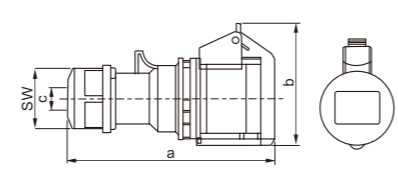

earth contact position	6h	
rated current(A)	16	32
pole	5	
dimension(mm)	a	145
	b	92
	c	8-16
	sw	42
cable nominal cross-section area(mm ²)	1-2.5	2.5-6





SFN-2332-4 SFN-2432-4

earth contact position	4h		
rated current(A)	63	125	
pole	3		
dimension(mm)	a	261	305
	b	114	115
	c	30	44.5
	d	112	130
cable nominal cross-section area(mm ²)	6-16	16-50	

电 流 Current(A): 63A. 125A
电 压 Voltage(V): 220-250V~2P+E
防护等级 Protection degree: IP67

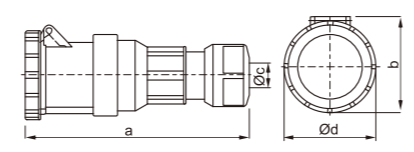

SFN-2332 SFN-2432

earth contact position	6h		
rated current(A)	63	125	
pole	3		
dimension(mm)	a	261	305
	b	114	115
	c	30	44.5
	d	112	130
cable nominal cross-section area(mm ²)	6-16	16-50	

电 流 Current(A): 63A. 125A
电 压 Voltage(V): 220-250V~2P+E
防护等级 Protection degree: IP67

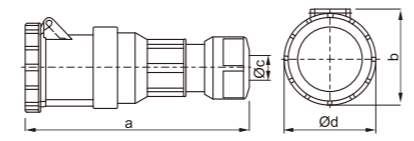

SFN-2342 SFN-2442

earth contact position	6h		
rated current(A)	63	125	
pole	4		
dimension(mm)	a	261	305
	b	114	115
	c	30	44.5
	d	112	130
cable nominal cross-section area(mm ²)	6-16	16-50	

电 流 Current(A): 63A. 125A
电 压 Voltage(V): 380-415V~3P+E
防护等级 Protection degree: IP67

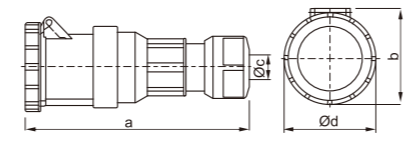

SFN-2352 SFN-2452

earth contact position	6h		
rated current(A)	63	125	
pole	5		
dimension(mm)	a	261	305
	b	114	115
	c	30	44.5
	d	112	130
cable nominal cross-section area(mm ²)	6-16	16-50	

电 流 Current(A): 63A. 125A
电 压 Voltage(V): 220-380V~240-415V~3P+N+E
防护等级 Protection degree: IP67

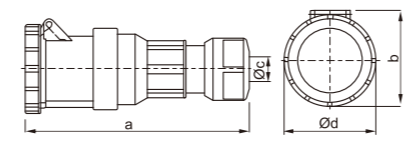

SFN-313-4 SFN-3234-4

earth contact position	4h		
rated current(A)	16	32	
pole	3		
dimension(mm)	axb	75	75
	cx	61	61
	d	22	24
	e	60	70
	f	5	5
	g	50	55
	h	87	95
cable nominal cross-section area(mm ²)	1-2.5	2.5-6	

电 流 Current(A): 16A. 32A
电 压 Voltage(V): 110-130V~2P+E
防护等级 Protection degree: IP44

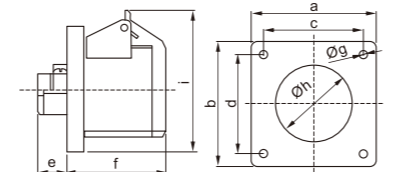

SFN-313 SFN-323

earth contact position	6h		
rated current(A)	16	32	
pole	3		
dimension(mm)	axb	75	75
	cx	61	61
	d	22	24
	e	60	70
	f	5	5
	g	50	55
	h	87	95
cable nominal cross-section area(mm ²)	1-2.5	2.5-6	

电 流 Current(A): 16A. 32A
电 压 Voltage(V): 220-240V~2P+E
防护等级 Protection degree: IP44

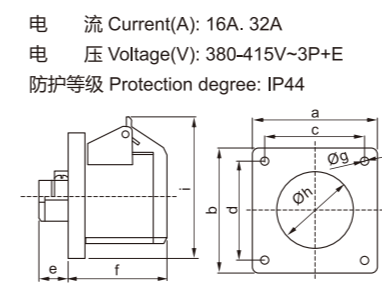
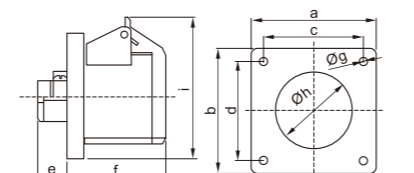

SFN-314 SFN-324

earth contact position	6h		
rated current(A)	16	32	
pole	4		
dimension(mm)	axb	75	75
	cx	61	61
	d	17	24
	e	59	69
	f	5	5
	g	50	55
	h	88	95
cable nominal cross-section area(mm ²)	1-2.5	2.5-6	

电 流 Current(A): 16A. 32A
电 压 Voltage(V): 380-415V~3P+E
防护等级 Protection degree: IP44

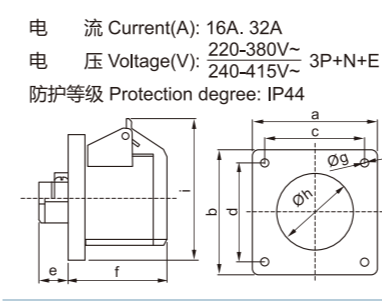
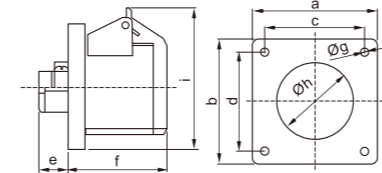

SFN-315 SFN-325

earth contact position	6h		
rated current(A)	16	32	
pole	5		
dimension(mm)	axb	75	75
	cx	61	61
	d	17	22
	e	59	71
	f	5	5
	g	55	60
	h	92	100
cable nominal cross-section area(mm ²)	1-2.5	2.5-6	

电 流 Current(A): 16A. 32A
电 压 Voltage(V): 220-380V~240-415V~3P+N+E
防护等级 Protection degree: IP44

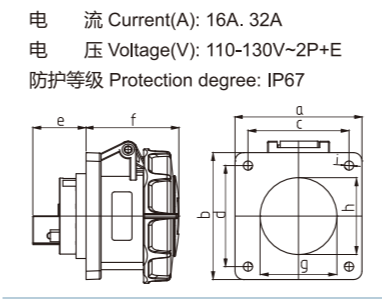
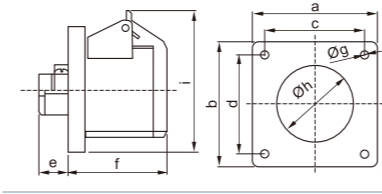

SFN-3132-4 SFN-3232-4

earth contact position	4h		
rated current(A)	16	32	
pole	3		
dimension(mm)	a	75	75
	b	75	75
	c	61	61
	d	61	61
	e	18	24
	f	63	70
	g	50	55
	h	50	55
	i	5	5
cable nominal cross-section area(mm ²)	1-2.5	2.5-6	

电 流 Current(A): 16A. 32A
电 压 Voltage(V): 110-130V~2P+E
防护等级 Protection degree: IP67

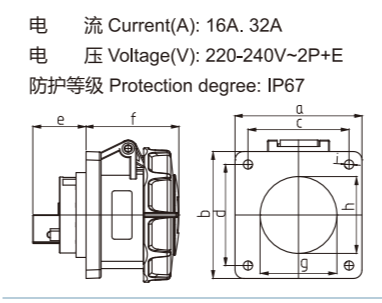
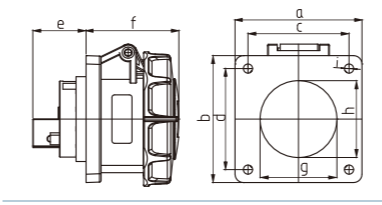

SFN-3132 SFN-3232

earth contact position	6h		
rated current(A)	16	32	
pole	3		
dimension(mm)	a	75	75
	b	75	75
	c	61	61
	d	61	61
	e	18	24
	f	63	70
	g	50	55
	h	50	55
	i	5	5
cable nominal cross-section area(mm ²)	1-2.5	2.5-6	

电 流 Current(A): 16A. 32A
电 压 Voltage(V): 220-240V~2P+E
防护等级 Protection degree: IP67

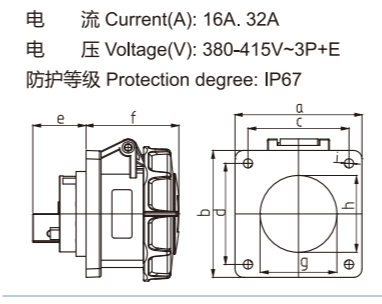
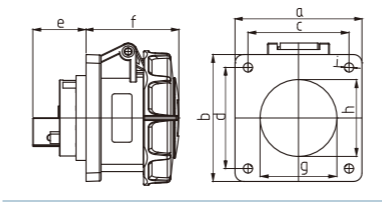

SFN-3142 SFN-3242

earth contact position	6h		
rated current(A)	16	32	
pole	4		
dimension(mm)	a	75	75
	b	75	75
	c	61	61
	d	61	61
	e	18	24
	f	63	73
	g	50	55
	h	50	55
	i	5	5
cable nominal cross-section area(mm ²)	1-2.5	2.5-6	

电 流 Current(A): 16A. 32A
电 压 Voltage(V): 380-415V~3P+E
防护等级 Protection degree: IP67

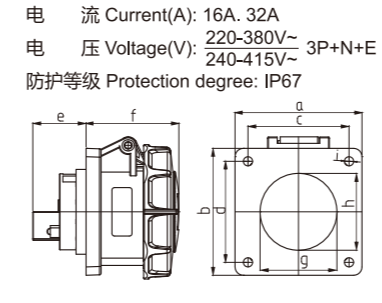
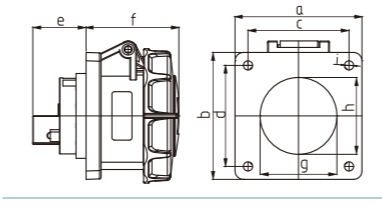

SFN-3152 SFN-3252

earth contact position	6h		
rated current(A)	16	32	
pole	5		
dimension(mm)	a	75	75
	b	75	75
	c	61	61
	d	61	61
	e	18	24
	f	63	76
	g	55	60
	h	55	60
	i	5	5
cable nominal cross-section area(mm ²)	1-2.5	2.5-6	

电 流 Current(A): 16A. 32A
电 压 Voltage(V): 220-380V~240-415V~3P+N+E
防护等级 Protection degree: IP67

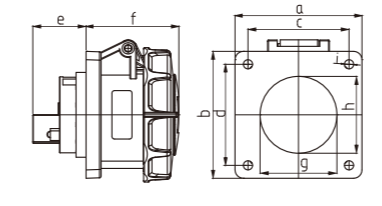



SFN-3332-4 SFN-3432-4

earth contact position	4h	
rated current(A)	63	125
pole	3	
dimension(mm)	a	120
	b	120
	c	101
	d	101
	e	44
	f	106
	g	100
	h	100
	i	7
cable nominal cross-section area(mm ²)	6-16	16-50

电 流 Current(A): 63A. 125A
电 压 Voltage(V): 220-250V~2P+E
防护等级 Protection degree: IP67

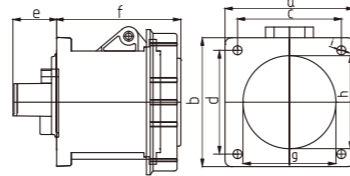

电 流 Current(A): 16A. 32A
电 压 Voltage(V): 380-415V~3P+E
防护等级 Protection degree: IP44

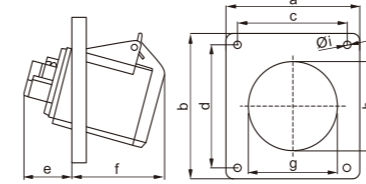

earth contact position	6h	
rated current(A)	16	32
pole	4	
dimension(mm)	a	85
	b	85
	c	70
	d	70
	e	50
	f	60
	g	76
	h	76
	i	5
cable nominal cross-section area(mm ²)	1-2.5	2.5-6



SFN-414 SFN-424



SFN-3332 SFN-3432

earth contact position	6h	
rated current(A)	63	125
pole	3	
dimension(mm)	a	120
	b	120
	c	101
	d	101
	e	44
	f	106
	g	100
	h	100
	i	7
cable nominal cross-section area(mm ²)	6-16	16-50

电 流 Current(A): 63A. 125A
电 压 Voltage(V): 220-250V~2P+E
防护等级 Protection degree: IP67

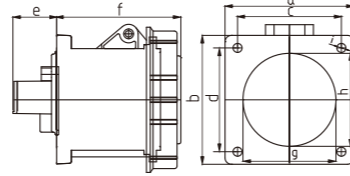

电 流 Current(A): 16A. 32A
电 压 Voltage(V): 220-380V~240-415V~3P+N+E
防护等级 Protection degree: IP44

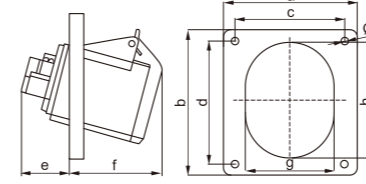

earth contact position	6h	
rated current(A)	16	32
pole	5	
dimension(mm)	a	85
	b	85
	c	70
	d	70
	e	50
	f	62
	g	70
	h	76
	i	5
cable nominal cross-section area(mm ²)	1-2.5	2.5-6



SFN-415 SFN-425



SFN-3342 SFN-3442

earth contact position	6h	
rated current(A)	63	125
pole	4	
dimension(mm)	a	120
	b	120
	c	101
	d	101
	e	44
	f	106
	g	100
	h	100
	i	7
cable nominal cross-section area(mm ²)	6-16	16-50

电 流 Current(A): 63A. 125A
电 压 Voltage(V): 380-415V~2P+E
防护等级 Protection degree: IP67

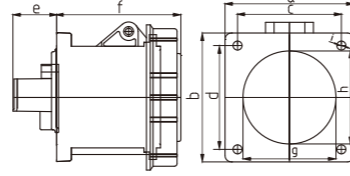

电 流 Current(A): 16A. 32A
电 压 Voltage(V): 220-240V~2P+E
防护等级 Protection degree: IP67

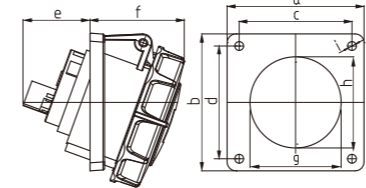

earth contact position	4h	
rated current(A)	16	32
pole	3	
dimension(mm)	a	85
	b	85
	c	70
	d	70
	e	50
	f	60
	g	76
	h	76
	i	5
cable nominal cross-section area(mm ²)	1-2.5	2.5-6



SFN-4132-4 SFN-4232-4



SFN-3352 SFN-3452

earth contact position	6h	
rated current(A)	63	125
pole	5	
dimension(mm)	a	120
	b	120
	c	101
	d	101
	e	44
	f	106
	g	100
	h	100
	i	7
cable nominal cross-section area(mm ²)	6-16	16-50

电 流 Current(A): 63A. 125A
电 压 Voltage(V): 220-380V~240-415V~3P+N+E
防护等级 Protection degree: IP67

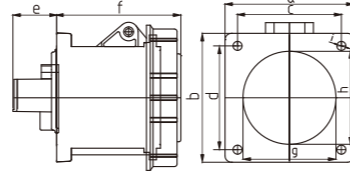

电 流 Current(A): 16A. 32A
电 压 Voltage(V): 220-240V~2P+E
防护等级 Protection degree: IP67

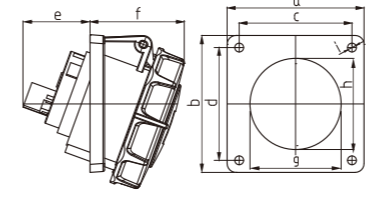

earth contact position	6h	
rated current(A)	16	32
pole	3	
dimension(mm)	a	85
	b	85
	c	70
	d	70
	e	50
	f	60
	g	76
	h	76
	i	5
cable nominal cross-section area(mm ²)	1-2.5	2.5-6



SFN-4132 SFN-4232



SFN-413-4 SFN-423-4

earth contact position	4h	
rated current(A)	16	32
pole	3	
dimension(mm)	a	85
	b	85
	c	70
	d	70
	e	50
	f	60
	g	76
	h	76
	i	5
cable nominal cross-section area(mm ²)	1-2.5	2.5-6

电 流 Current(A): 16A. 32A
电 压 Voltage(V): 220-240V~2P+E
防护等级 Protection degree: IP44

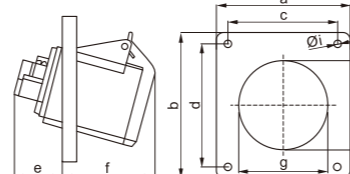

电 流 Current(A): 16A. 32A
电 压 Voltage(V): 380-415V~3P+E
防护等级 Protection degree: IP67

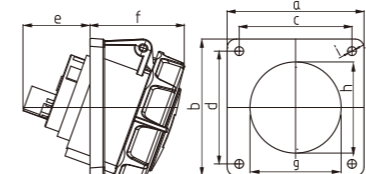

earth contact position	6h	
rated current(A)	16	32
pole	4	
dimension(mm)	a	85
	b	85
	c	70
	d	70
	e	50
	f	60
	g	76
	h	76
	i	5
cable nominal cross-section area(mm ²)	1-2.5	2.5-6



SFN-4142 SFN-4242



SFN-413 SFN-423

earth contact position	6h	
rated current(A)	16	32
pole	3	
dimension(mm)	a	85
	b	85
	c	70
	d	70
	e	50
	f	60
	g	76
	h	76
	i	5
cable nominal cross-section area(mm ²)	1-2.5	2.5-6

电 流 Current(A): 16A. 32A
电 压 Voltage(V): 220-240V~2P+E
防护等级 Protection degree: IP44

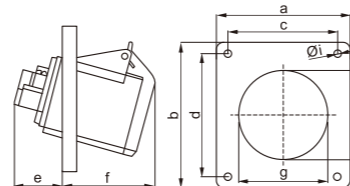

电 流 Current(A): 16A. 32A
电 压 Voltage(V): 220-380V~240-415V~3P+N+E
防护等级 Protection degree: IP67

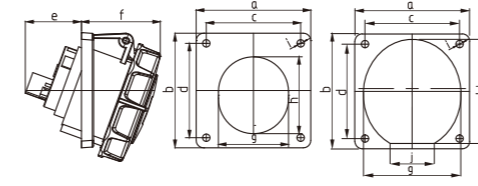

earth contact position	6h	
rated current(A)	16	32
pole	5	
dimension(mm)	a	85
	b	85
	c	70
	d	70
	e	50
	f	62
	g	70
	h	76
	i	5
	j	36
cable nominal cross-section area(mm ²)	1-2.5	2.5-6



SFN-4152 SFN-4252



SFN-4332-4 SFN-4432-4

earth contact position	4h	
rated current(A)	63	125
pole	3	3
dimension(mm)		
a	101	120
b	113	131
c	80	100
d	89	108
e	64	87
f	83	82
g	87	105
h	87	105
i	7	7.5
cable nominal cross-section area(mm ²)	6-25	16-50

电 流 Current(A): 63A. 125A
电 压 Voltage(V): 220-240V~2P+E
防护等级 Protection degree: IP67

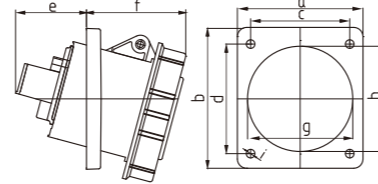

SFN-4332 SFN-4432

earth contact position	6h	
rated current(A)	63	125
pole	3	3
dimension(mm)		
a	101	120
b	113	131
c	80	100
d	89	108
e	64	87
f	83	82
g	87	105
h	87	105
i	7	7.5
cable nominal cross-section area(mm ²)	6-25	16-50

电 流 Current(A): 63A. 125A
电 压 Voltage(V): 220-240V~2P+E
防护等级 Protection degree: IP67

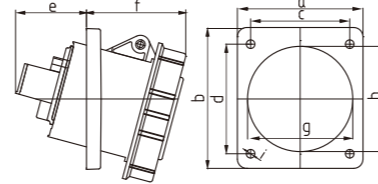

SFN-4342 SFN-4442

earth contact position	6h	
rated current(A)	63	125
pole	4	4
dimension(mm)		
a	101	120
b	113	131
c	80	100
d	89	108
e	64	87
f	83	82
g	87	105
h	87	105
i	7	7.5
cable nominal cross-section area(mm ²)	6-25	16-50

电 流 Current(A): 63A. 125A
电 压 Voltage(V): 380-415V~3P+E
防护等级 Protection degree: IP67

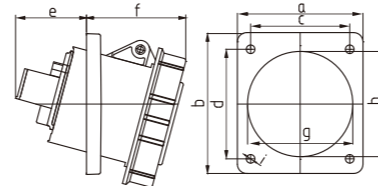

SFN-4352 SFN-4452

earth contact position	6h	
rated current(A)	63	125
pole	5	5
dimension(mm)		
a	101	120
b	113	131
c	80	100
d	89	108
e	64	87
f	83	82
g	87	105
h	87	105
i	7	7.5
cable nominal cross-section area(mm ²)	6-25	16-50

电 流 Current(A): 63A. 125A
电 压 Voltage(V): 220-380V~240-415V~3P+N+E
防护等级 Protection degree: IP67

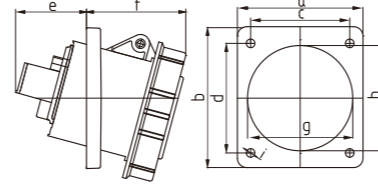

新型器具插座 New Implement Socket



SFN-513-4 SFN-523-4

earth contact position	4h	
rated current(A)	16	32
pole	3	3
dimension(mm)		
a	133	143
b	81	81
cable nominal cross-section area(mm ²)	1-2.5	2.5-6

电 流 Current(A): 16A. 32A
电 压 Voltage(V): 110-130V~2P+E
防护等级 Protection degree: IP44

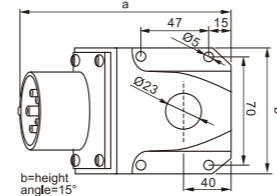

SFN-513 SFN-523

earth contact position	6h	
rated current(A)	16	32
pole	3	3
dimension(mm)		
a	133	143
b	81	81
cable nominal cross-section area(mm ²)	1-2.5	2.5-6

电 流 Current(A): 16A. 32A
电 压 Voltage(V): 220-240V~2P+E
防护等级 Protection degree: IP44

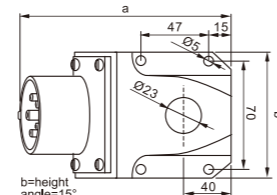

电 流 Current(A): 16A. 32A
电 压 Voltage(V): 380V-415V~3P+E
防护等级 Protection degree: IP44

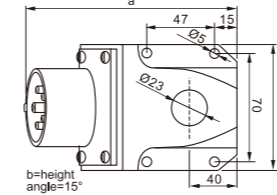

earth contact position	6h	
rated current(A)	16	32
pole	4	4
dimension(mm)		
a	133	143
b	81	81
cable nominal cross-section area(mm ²)	1-2.5	2.5-6



SFN-514 SFN-524

电 流 Current(A): 16A. 32A
电 压 Voltage(V): 220-380V~240-415V~3P+N+E
防护等级 Protection degree: IP44

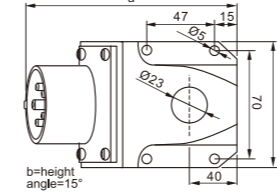

earth contact position	6h	
rated current(A)	16	32
pole	5	5
dimension(mm)		
a	133	143
b	81	81
cable nominal cross-section area(mm ²)	1-2.5	2.5-6



SFN-515 SFN-525

电 流 Current(A): 16A. 32A
电 压 Voltage(V): 110-130V~2P+E
防护等级 Protection degree: IP67

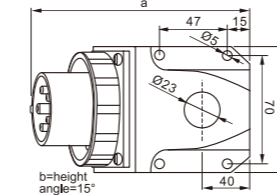

earth contact position	4h	
rated current(A)	16	32
pole	3	3
dimension(mm)		
a	133	143
b	81	81
cable nominal cross-section area(mm ²)	1-2.5	2.5-6

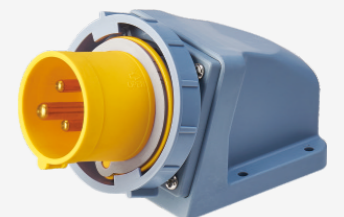

SFN-5132-4 SFN-5232-4

电 流 Current(A): 16A. 32A
电 压 Voltage(V): 220-240V~2P+E
防护等级 Protection degree: IP67

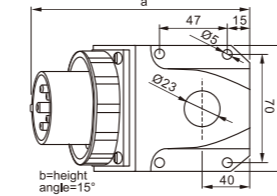

earth contact position	6h	
rated current(A)	16	32
pole	3	3
dimension(mm)		
a	133	143
b	81	81
cable nominal cross-section area(mm ²)	1-2.5	2.5-6

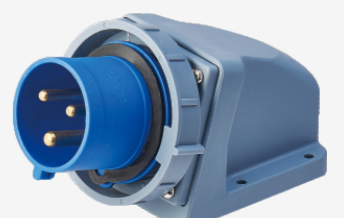

SFN-5132 SFN-5232

电 流 Current(A): 16A. 32A
电 压 Voltage(V): 380V-415V~3P+E
防护等级 Protection degree: IP67

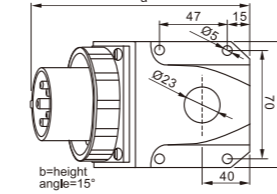

earth contact position	6h	
rated current(A)	16	32
pole	4	4
dimension(mm)		
a	133	143
b	81	81
cable nominal cross-section area(mm ²)	1-2.5	2.5-6

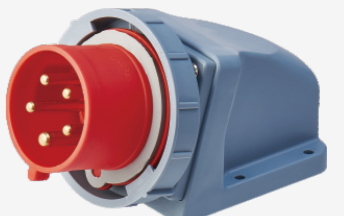

SFN-5142 SFN-5242

电 流 Current(A): 16A. 32A
电 压 Voltage(V): 220-380V~240-415V~3P+N+E
防护等级 Protection degree: IP67

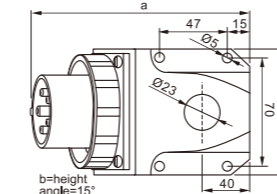

earth contact position	6h	
rated current(A)	16	32
pole	5	5
dimension(mm)		
a	133	143
b	81	81
cable nominal cross-section area(mm ²)	1-2.5	2.5-6



SFN-5152 SFN-5252



SFN-5332-4 SFN-5432-4

earth contact position	4h	
rated current(A)	63	125
	pole 3	
dimension(mm)	a	193
	b	123
	c	153
	d	111
	e	21
	f	6
	g	288
	h	127
	PG	29
		36
cable nominal cross-section area(mm ²)	6-16	16-50

电 流 Current(A): 63A. 125A
电 压 Voltage(V): 220-240V~2P+E
防护等级 Protection degree: IP67

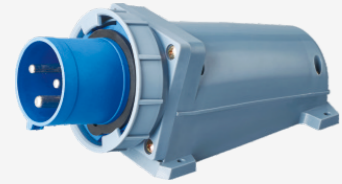
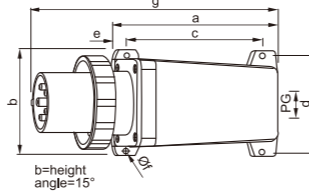

SFN-5332 SFN-5432

earth contact position	6h	
rated current(A)	63	125
	pole 3	
dimension(mm)	a	193
	b	123
	c	153
	d	111
	e	21
	f	6
	g	288
	h	127
	PG	29
		36
cable nominal cross-section area(mm ²)	6-16	16-50

电 流 Current(A): 63A. 125A
电 压 Voltage(V): 220-240V~2P+E
防护等级 Protection degree: IP67

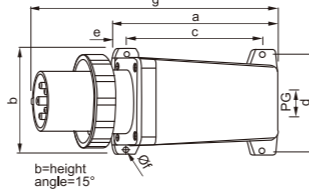

SFN-5342 SFN-5442

earth contact position	6h	
rated current(A)	63	125
	pole 4	
dimension(mm)	a	193
	b	123
	c	153
	d	111
	e	21
	f	6
	g	288
	h	127
	PG	29
		36
cable nominal cross-section area(mm ²)	6-16	16-50

电 流 Current(A): 63A. 125A
电 压 Voltage(V): 380-415V~3P+E
防护等级 Protection degree: IP67

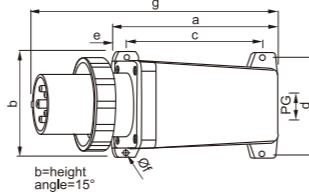

SFN-5352 SFN-5452

earth contact position	6h	
rated current(A)	63	125
	pole 5	
dimension(mm)	a	193
	b	123
	c	153
	d	111
	e	21
	f	6
	g	288
	h	127
	PG	29
		36
cable nominal cross-section area(mm ²)	6-16	16-50

电 流 Current(A): 63A. 125A
电 压 Voltage(V): 220-380V~ 240-415V~ 3P+N+E
防护等级 Protection degree: IP67

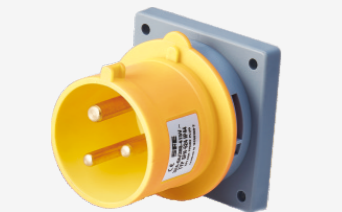
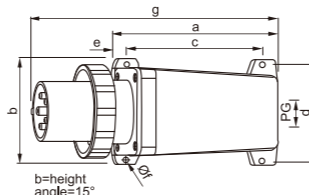

SFN-613-4 SFN-623-4

earth contact position	4h	
rated current(A)	16	32
	pole 3	
dimension(mm)	a	75
	b	75
	c	61
	d	61
	e	25
	f	41
	g	5
	h	43
		55
cable nominal cross-section area(mm ²)	1-2.5	2.5-6

电 流 Current(A): 16A. 32A
电 压 Voltage(V): 110-130V~2P+E
防护等级 Protection degree: IP44

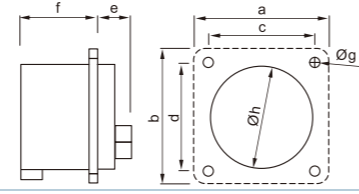

SFN-613 SFN-623

earth contact position	6h	
rated current(A)	16	32
	pole 3	
dimension(mm)	a	75
	b	75
	c	61
	d	61
	e	25
	f	41
	g	5
	h	43
		55
cable nominal cross-section area(mm ²)	1-2.5	2.5-6

电 流 Current(A): 16A. 32A
电 压 Voltage(V): 220-240V~2P+E
防护等级 Protection degree: IP44

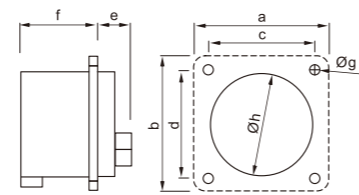

电 流 Current(A): 16A. 32A
电 压 Voltage(V): 380-415V~3P+E
防护等级 Protection degree: IP44

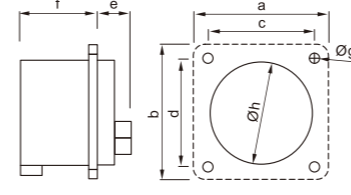

earth contact position	6h	
rated current(A)	16	32
	pole 4	
dimension(mm)	a	75
	b	75
	c	61
	d	61
	e	25
	f	41
	g	5
	h	43
		55
cable nominal cross-section area(mm ²)	1-2.5	2.5-6

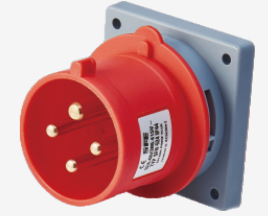

SFN-614 SFN-624

电 流 Current(A): 16A. 32A
电 压 Voltage(V): 220-380V~ 240-415V~ 3P+N+E
防护等级 Protection degree: IP44

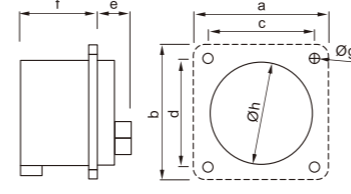

earth contact position	6h	
rated current(A)	16	32
	pole 5	
dimension(mm)	a	75
	b	75
	c	61
	d	61
	e	26
	f	42
	g	5
	h	55
		55
cable nominal cross-section area(mm ²)	1-2.5	2.5-6



SFN-615 SFN-625

电 流 Current(A): 16A. 32A
电 压 Voltage(V): 110-130V~2P+E
防护等级 Protection degree: IP67

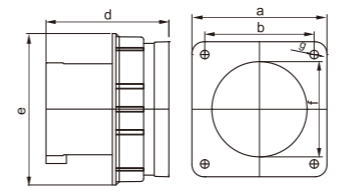

earth contact position	4h	
rated current(A)	16	32
	pole 3	
dimension(mm)	a	75
	b	61
	d	64
	e	74
	f	40
	g	5.5
		5.5
cable nominal cross-section area(mm ²)	1-2.5	2.5-6

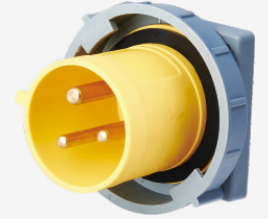

SFN-6132-4 SFN-6232-4

电 流 Current(A): 16A. 32A
电 压 Voltage(V): 220-240V~2P+E
防护等级 Protection degree: IP67

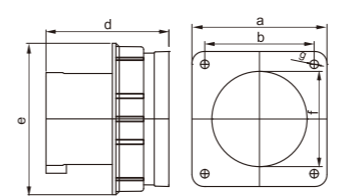

earth contact position	6h	
rated current(A)	16	32
	pole 3	
dimension(mm)	a	75
	b	61
	d	64
	e	74
	f	40
	g	5.5
		5.5
cable nominal cross-section area(mm ²)	1-2.5	2.5-6



SFN-6132 SFN-6232

电 流 Current(A): 16A. 32A
电 压 Voltage(V): 380-415V~3P+E
防护等级 Protection degree: IP67

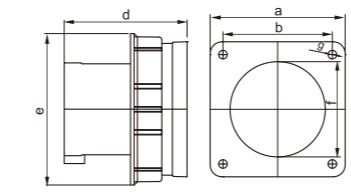

earth contact position	6h	
rated current(A)	16	32
	pole 4	
dimension(mm)	a	75
	b	61
	d	65
	e	83
	f	48
	g	5.5
		5.5
cable nominal cross-section area(mm ²)	1-2.5	2.5-6

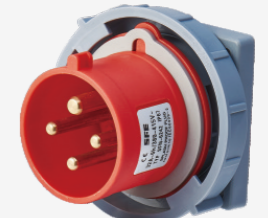

SFN-6142 SFN-6242

电 流 Current(A): 16A. 32A
电 压 Voltage(V): 220-380V~ 240-415V~ 3P+N+E
防护等级 Protection degree: IP67

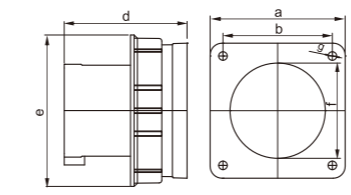

earth contact position	6h	
rated current(A)	16	32
	pole 5	
dimension(mm)	a	75
	b	61
	d	65
	e	90
	f	53
	g	5.5
		5.5
cable nominal cross-section area(mm ²)	1-2.5	2.5-6

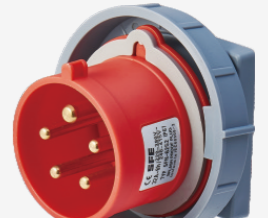

SFN-6152 SFN-6252



earth contact position	6h
rated current(A)	200
pole	4
dimension(mm)	a 302 b 142 c 134 d 65 Ø 45-66
cable nominal cross-section area(mm ²)	45-66

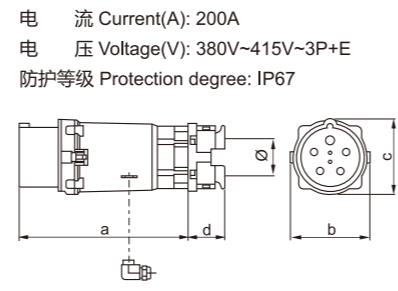

earth contact position	6h
rated current(A)	200
pole	4
dimension(mm)	a 140 b 140 c 120 d 120 e 145 f 20 g 120 h 178 i 9 j 36
cable nominal cross-section area(mm ²)	45-66

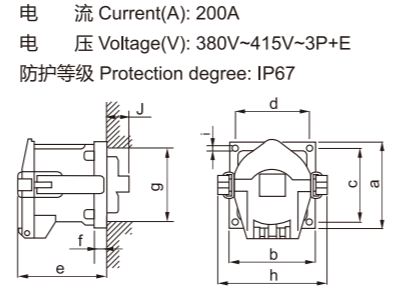

earth contact position	6h
rated current(A)	200
pole	4
dimension(mm)	a 328 b 162 c 65 Ø 45-66
cable nominal cross-section area(mm ²)	45-66

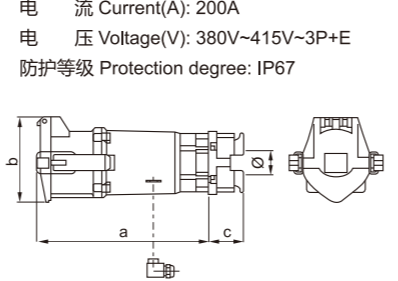

earth contact position	6h
rated current(A)	200
pole	5
dimension(mm)	a 302 b 142 c 134 d 65 Ø 45-66
cable nominal cross-section area(mm ²)	45-66

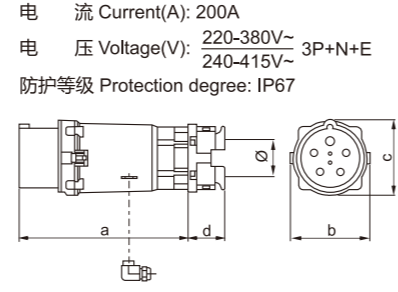

earth contact position	6h
rated current(A)	200
pole	5
dimension(mm)	a 140 b 140 c 120 d 120 e 145 f 20 g 120 h 178 i 9 j 36
cable nominal cross-section area(mm ²)	45-66

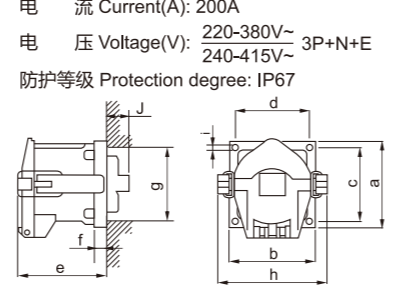

earth contact position	6h
rated current(A)	200
pole	5
dimension(mm)	a 328 b 162 c 65 Ø 45-66
cable nominal cross-section area(mm ²)	45-66

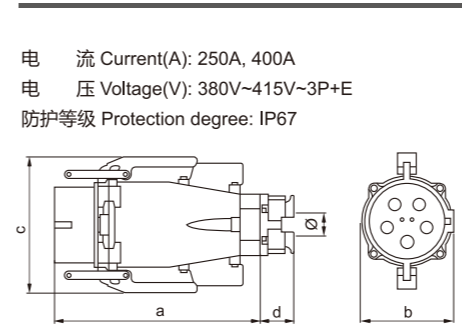
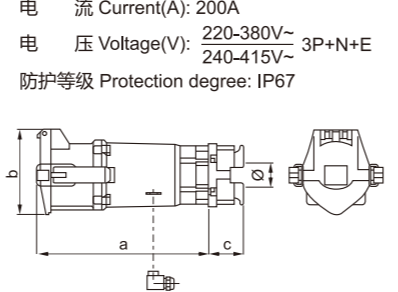

earth contact position	6h
rated current(A)	250, 400
pole	4
dimension(mm)	a 402 b 179 c 264 d 65 Ø 45-66
cable nominal cross-section area(mm ²)	45-66

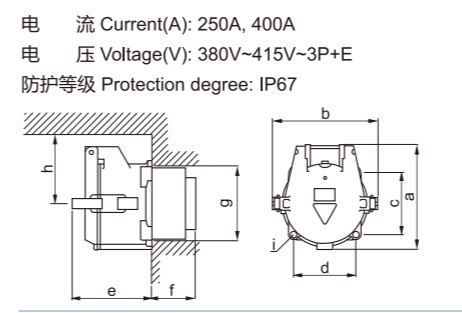
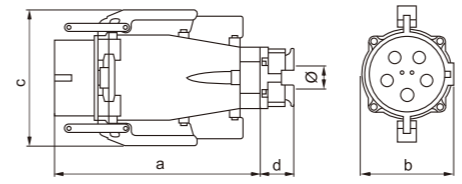

earth contact position	6h
rated current(A)	250, 400
pole	4
dimension(mm)	a 213 b 216 c 127 d 127 e 157 f 90 g 153 h 140 i 6
cable nominal cross-section area(mm ²)	45-66

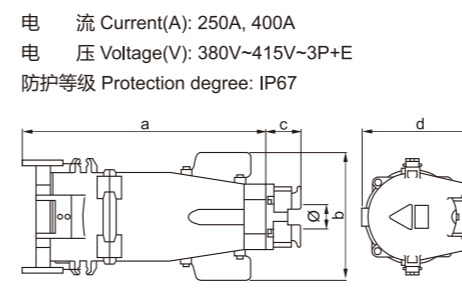
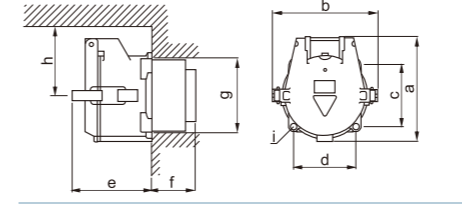

earth contact position	6h
rated current(A)	250, 400
pole	4
dimension(mm)	a 447 b 238 c 65 d 213 Ø 45-66
cable nominal cross-section area(mm ²)	45-66

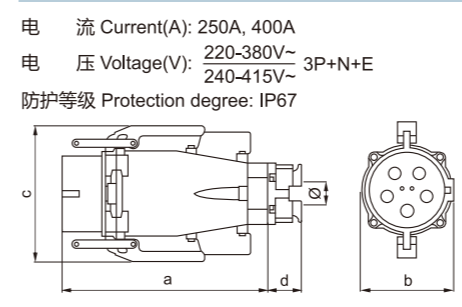
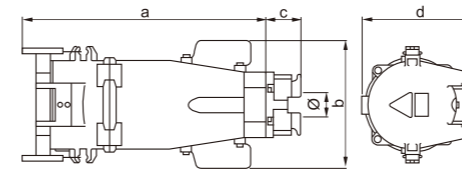

earth contact position	6h
rated current(A)	250, 400
pole	5
dimension(mm)	a 402 b 179 c 264 d 65 Ø 45-66
cable nominal cross-section area(mm ²)	45-66

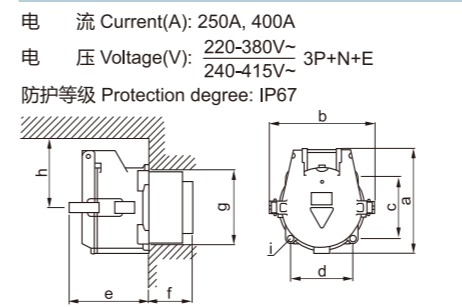
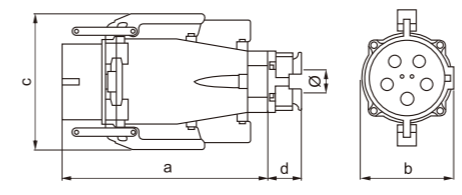

earth contact position	6h
rated current(A)	250, 400
pole	5
dimension(mm)	a 213 b 216 c 127 d 127 e 157 f 90 g 153 h 140 i 6
cable nominal cross-section area(mm ²)	45-66

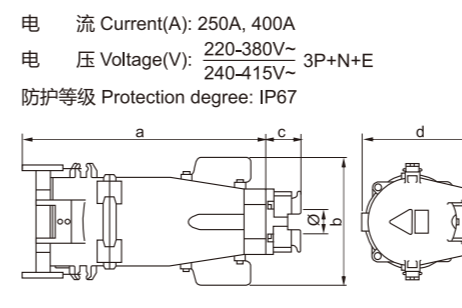
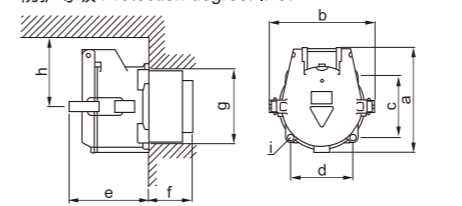

earth contact position	6h
rated current(A)	250, 400
pole	5
dimension(mm)	a 447 b 238 c 65 d 213 Ø 45-66
cable nominal cross-section area(mm ²)	45-66

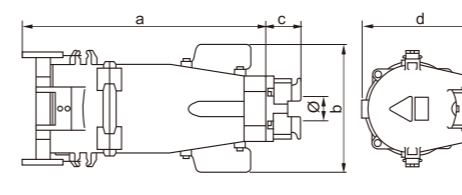

工业用插头 Industrial plug



SF-013-4 SF-023-4

earth contact position	4h		
rated current(A)	16	32	
pole	3		
dimension(mm)	a	122	139
	b	59	75
	c	51	64
	Ø	6	8
cable nominal cross-section area(mm ²)	1-2.5	2.5-6	

电 流 Current(A): 16A. 32A
电 压 Voltage(V): 110-130V~2P+E
防护等级 Protection degree: IP44

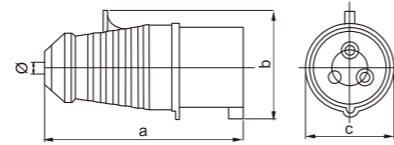

SF-013 SF-023

earth contact position	6h		
rated current(A)	16	32	
pole	3		
dimension(mm)	a	122	139
	b	59	75
	c	51	64
	Ø	6	8
cable nominal cross-section area(mm ²)	1-2.5	2.5-6	

电 流 Current(A): 16A. 32A
电 压 Voltage(V): 220-240V~2P+E
防护等级 Protection degree: IP44

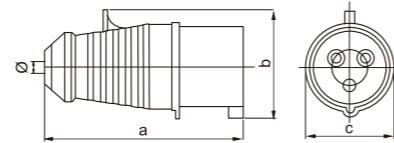

SF-014 SF-024

earth contact position	6h		
rated current(A)	16	32	
pole	4		
dimension(mm)	a	122	139
	b	65	75
	c	55	64
	Ø	6	8
cable nominal cross-section area(mm ²)	1-2.5	2.5-6	

电 流 Current(A): 16A. 32A
电 压 Voltage(V): 380-415V~3P+E
防护等级 Protection degree: IP44

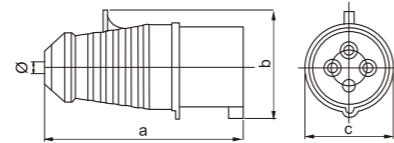

SF-015 SF-025

earth contact position	6h		
rated current(A)	16	32	
pole	5		
dimension(mm)	a	130	143
	b	72	84
	c	64	70
	Ø	8	8
cable nominal cross-section area(mm ²)	1-2.5	2.5-6	

电 流 Current(A): 16A. 32A
电 压 Voltage(V): 220-380V~240-415V~3P+N+E
防护等级 Protection degree: IP44

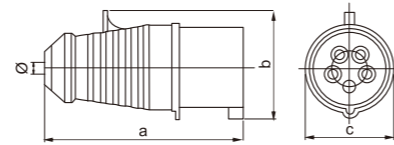

SF-033 SF-043

earth contact position	6h		
rated current(A)	63	125	
pole	3		
dimension(mm)	a	231.5	293
	b	110	125
	c	16-38	30-50
	Ø	110	125
cable nominal cross-section area(mm ²)	6-16	16-50	

电 流 Current(A): 63A. 125A
电 压 Voltage(V): 220-240V~2P+E
防护等级 Protection degree: IP67

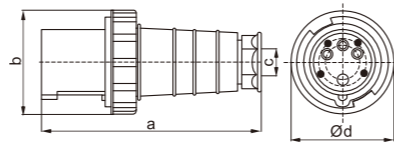



SF-034 SF-044

earth contact position	6h		
rated current(A)	63	125	
pole	4		
dimension(mm)	a	231.5	293
	b	110	125
	c	16-38	30-50
	Ø	110	125
cable nominal cross-section area(mm ²)	6-16	16-50	

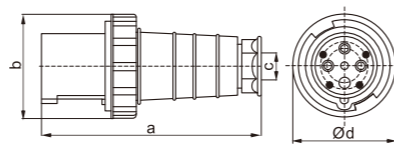
电 流 Current(A): 63A. 125A
电 压 Voltage(V): 380-415V~3P+E
防护等级 Protection degree: IP67

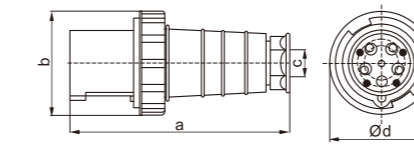

电 流 Current(A): 63A. 125A
电 压 Voltage(V): 220-380V~240-415V~3P+N+E
防护等级 Protection degree: IP67



earth contact position	6h		
rated current(A)	63	125	
pole	5		
dimension(mm)	a	231.5	293
	b	110	125
	c	16-38	30-50
	Ø	110	125
cable nominal cross-section area(mm ²)	6-16	16-50	



SF-035 SF-045

电 流 Current(A): 16A. 32A
电 压 Voltage(V): 110-130V~2P+E
防护等级 Protection degree: IP44

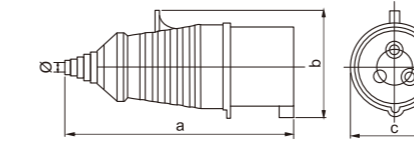

earth contact position	4h		
rated current(A)	16	32	
pole	3		
dimension(mm)	a	141	178
	b	59	75
	c	51	64
	Ø	8	10
cable nominal cross-section area(mm ²)	1-2.5	2.5-6	

电缆保护插头 Cable sheath plug



SF-013L-4 SF-023L-4

电 流 Current(A): 16A. 32A
电 压 Voltage(V): 220-240V~2P+E
防护等级 Protection degree: IP44

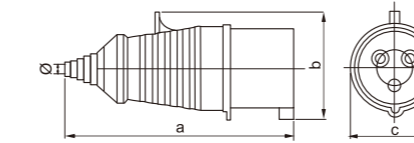

earth contact position	6h		
rated current(A)	16	32	
pole	3		
dimension(mm)	a	141	178
	b	59	75
	c	51	64
	Ø	8	10
cable nominal cross-section area(mm ²)	1-2.5	2.5-6	



SF-013L SF-023L

电 流 Current(A): 16A. 32A
电 压 Voltage(V): 380-415V~3P+E
防护等级 Protection degree: IP44

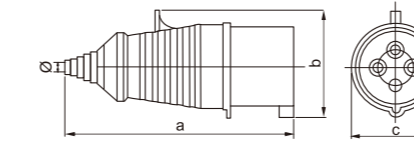

earth contact position	6h		
rated current(A)	16	32	
pole	4		
dimension(mm)	a	141	178
	b	65	75
	c	55	64
	Ø	8	10
cable nominal cross-section area(mm ²)	1-2.5	2.5-6	



SF-014L SF-024L

电 流 Current(A): 16A. 32A
电 压 Voltage(V): 220-380V~240-415V~3P+N+E
防护等级 Protection degree: IP44

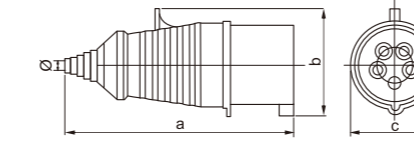

earth contact position	6h		
rated current(A)	16	32	
pole	5		
dimension(mm)	a	169	181
	b	72	84
	c	64	70
	Ø	10	10
cable nominal cross-section area(mm ²)	1-2.5	2.5-6	



SF-015L SF-025L

电 流 Current(A): 16A. 32A
电 压 Voltage(V): 110-130V~2P+E
防护等级 Protection degree: IP44

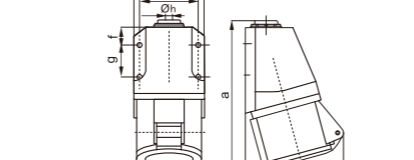

earth contact position	4h		
rated current(A)	16	32	
pole	3		
dimension(mm)	a	135	153
	b	92	102
	c	71	71
	d	50	65
	e	57	57
	f	20	20
	g	32.5	32.5
	h	6.5	6.5
cable nominal cross-section area(mm ²)	1-2.5	2.5-6	

工业用明装插座 Industrial socket



SF-113-4 SF-123-4



SF-113 SF-123

earth contact position	6h	
rated current(A)	16	32
	pole 3	
dimension(mm)	a	135
	b	92
	c	71
	d	50
	e	57
	f	20
	g	32.5
	h	6.5
cable nominal cross-section area(mm ²)	1-2.5	2.5-6

电 流 Current(A): 16A. 32A
电 压 Voltage(V): 220-240V~2P+E
防护等级 Protection degree: IP44

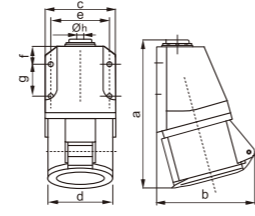

SF-114 SF-124

earth contact position	6h	
rated current(A)	16	32
	pole 4	
dimension(mm)	a	140
	b	95
	c	71
	d	56
	e	57
	f	20
	g	32.5
	h	6.5
cable nominal cross-section area(mm ²)	1-2.5	2.5-6

电 流 Current(A): 16A. 32A
电 压 Voltage(V): 380-415V~3P+E
防护等级 Protection degree: IP44

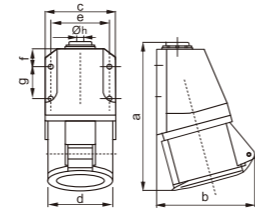

SF-115 SF-125

earth contact position	6h	
rated current(A)	16	32
	pole 5	
dimension(mm)	a	139
	b	100
	c	71
	d	63
	e	57
	f	20
	g	32.5
	h	6.5
cable nominal cross-section area(mm ²)	1-2.5	2.5-6

电 流 Current(A): 16A. 32A
电 压 Voltage(V): 220-380V~ 3P+N+E
240-415V~ 3P+N+E
防护等级 Protection degree: IP44

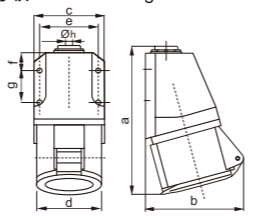

SF-133 SF-143

earth contact position	6h	
rated current(A)	63	125
	pole 3	
dimension(mm)	a	134
	b	311
	c	108
	d	111
	e	20
	f	153
	g	6
cable nominal cross-section area(mm ²)	6-25	25-70

电 流 Current(A): 63A. 125A
电 压 Voltage(V): 220-240V~2P+E
防护等级 Protection degree: IP67

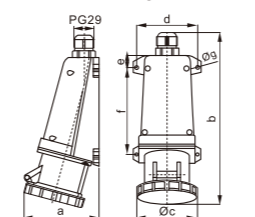

SF-134 SF-144

earth contact position	6h	
rated current(A)	63	125
	pole 4	
dimension(mm)	a	134
	b	311
	c	108
	d	111
	e	20
	f	153
	g	6
cable nominal cross-section area(mm ²)	6-25	25-70

电 流 Current(A): 63A. 125A
电 压 Voltage(V): 380-415V~3P+E
防护等级 Protection degree: IP67

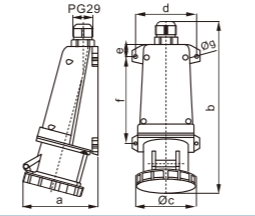

SF-135 SF-145

earth contact position	6h	
rated current(A)	63	125
	pole 5	
dimension(mm)	a	134
	b	311
	c	108
	d	111
	e	20
	f	153
	g	6
cable nominal cross-section area(mm ²)	6-25	25-70

电 流 Current(A): 63A. 125A
电 压 Voltage(V): 220-380V~ 3P+N+E
240-415V~ 3P+N+E
防护等级 Protection degree: IP67

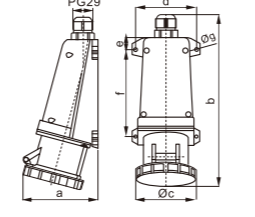

电 流 Current(A): 16A. 32A
电 压 Voltage(V): 110-130V~2P+E
防护等级 Protection degree: IP44

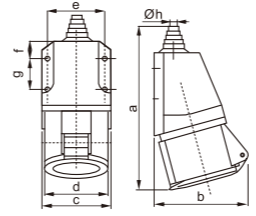

earth contact position	4h	
rated current(A)	16	32
	pole 3	
dimension(mm)	a	168
	b	92
	c	71
	d	50
	e	57
	f	20
	g	32.5
	h	6.5
cable nominal cross-section area(mm ²)	1-2.5	2.5-6

电缆保护套插座 Cable sheath socket



SF-113L-4 SF-123L-4

电 流 Current(A): 16A. 32A
电 压 Voltage(V): 220-240V~2P+E
防护等级 Protection degree: IP44

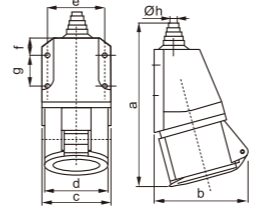

earth contact position	6h	
rated current(A)	16	32
	pole 3	
dimension(mm)	a	168
	b	92
	c	71
	d	50
	e	57
	f	20
	g	32.5
	h	6.5
cable nominal cross-section area(mm ²)	1-2.5	2.5-6



SF-113L SF-123L

电 流 Current(A): 16A. 32A
电 压 Voltage(V): 380-415V~3P+E
防护等级 Protection degree: IP44

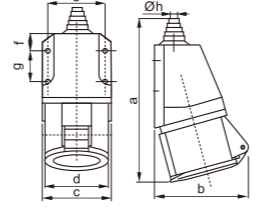

earth contact position	6h	
rated current(A)	16	32
	pole 4	
dimension(mm)	a	170
	b	95
	c	71
	d	56
	e	57
	f	20
	g	32.5
	h	6.5
cable nominal cross-section area(mm ²)	1-2.5	2.5-6

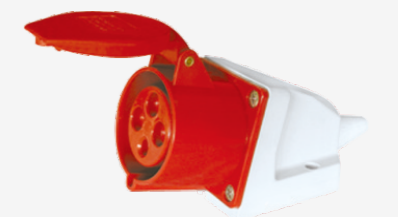

SF-114L SF-124L

电 流 Current(A): 16A. 32A
电 压 Voltage(V): 220-380V~ 3P+N+E
240-415V~ 3P+N+E
防护等级 Protection degree: IP44

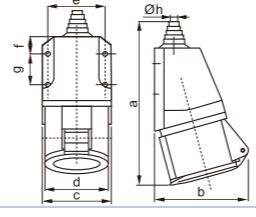

earth contact position	6h	
rated current(A)	16	32
	pole 5	
dimension(mm)	a	166
	b	100
	c	71
	d	63
	e	57
	f	20
	g	32.5
	h	6.5
cable nominal cross-section area(mm ²)	1-2.5	2.5-6



SF-115L SF-125L

电 流 Current(A): 16A. 32A
电 压 Voltage(V): 110-130V~2P+E
防护等级 Protection degree: IP44

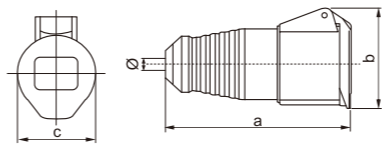

earth contact position	4h	
rated current(A)	16	32
	pole 3	
dimension(mm)	a	131
	b	68
	c	50
	φ	6
cable nominal cross-section area(mm ²)	1-2.5	2.5-6

工业用连接器 Industrial connector

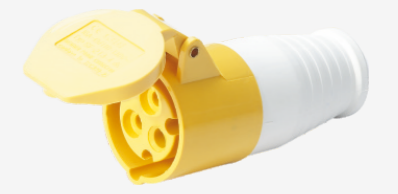

SF-213-4 SF-223-4

电 流 Current(A): 16A. 32A
电 压 Voltage(V): 220-240V~2P+E
防护等级 Protection degree: IP44

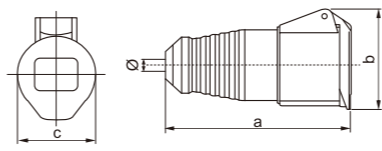

earth contact position	6h	
rated current(A)	16	32
	pole 3	
dimension(mm)	a	131
	b	68
	c	50
	φ	6
cable nominal cross-section area(mm ²)	1-2.5	2.5-6



SF-213 SF-223



SF-214 SF-224

earth contact position	6h		
rated current(A)	16	32	
pole	4		
dimension(mm)	a	131	150
	b	79	92
	c	56	65
	φ	6	8
cable nominal cross-section area(mm ²)	1-2.5	2.5-6	

电 流 Current(A): 16A. 32A
电 压 Voltage(V): 380-415V~3P+E
防护等级 Protection degree: IP44

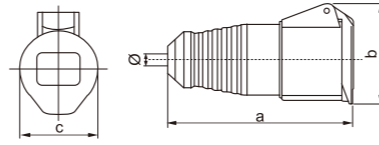

电 流 Current(A): 16A. 32A
电 压 Voltage(V): 220-240V~2P+E
防护等级 Protection degree: IP44

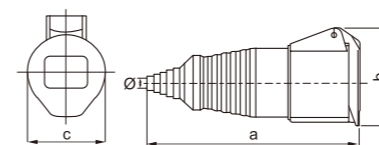

earth contact position	6h		
rated current(A)	16	32	
pole	3		
dimension(mm)	a	150	189
	b	68	92
	c	50	65
	Ø	8	10
cable nominal cross-section area(mm ²)	1-2.5	2.5-6	



SF-213L SF-223L



SF-215 SF-225

earth contact position	6h		
rated current(A)	16	32	
pole	5		
dimension(mm)	a	139	154
	b	90	100
	c	63	70.5
	φ	8	8
cable nominal cross-section area(mm ²)	1-2.5	2.5-6	

电 流 Current(A): 16A. 32A
电 压 Voltage(V): 220-380V~ 3P+N+E
240-415V~
防护等级 Protection degree: IP44

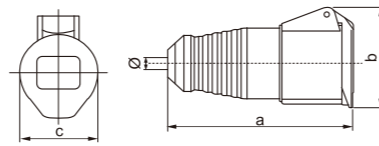

电 流 Current(A): 16A. 32A
电 压 Voltage(V): 380-415V~3P+E
防护等级 Protection degree: IP44

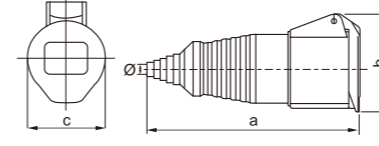

earth contact position	6h		
rated current(A)	16	32	
pole	4		
dimension(mm)	a	149	189
	b	79	92
	c	56	65
	Ø	8	10
cable nominal cross-section area(mm ²)	1-2.5	2.5-6	



SF-214L SF-224L



SF-233 SF-243

earth contact position	6h		
rated current(A)	63	125	
pole	3		
dimension(mm)	a	240	303
	b	115	128
	c	16-38	30-50
	d	108	120
cable nominal cross-section area(mm ²)	6-16	16-50	

电 流 Current(A): 63A. 125A
电 压 Voltage(V): 220-240V~2P+E
防护等级 Protection degree: IP67

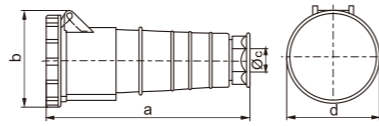

电 流 Current(A): 16A. 32A
电 压 Voltage(V): 220-380V~ 3P+N+E
240-415V~
防护等级 Protection degree: IP44

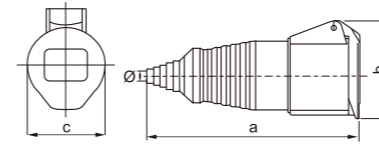

earth contact position	6h		
rated current(A)	16	32	
pole	5		
dimension(mm)	a	179	193
	b	90	100
	c	63	70.5
	Ø	10	10
cable nominal cross-section area(mm ²)	1-2.5	2.5-6	

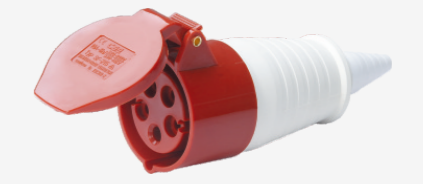

SF-215L SF-225L



SF-234 SF-244

earth contact position	6h		
rated current(A)	63	125	
pole	4		
dimension(mm)	a	240	303
	b	115	128
	c	16-38	30-50
	d	108	120
cable nominal cross-section area(mm ²)	6-16	16-50	

电 流 Current(A): 63A. 125A
电 压 Voltage(V): 380-415V~3P+E
防护等级 Protection degree: IP67

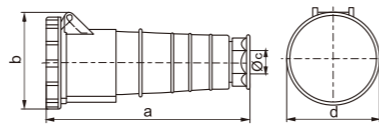

电 流 Current(A): 16A. 32A
电 压 Voltage(V): 110-130V~2P+E
防护等级 Protection degree: IP44

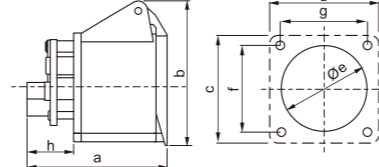

earth contact position	4h		
rated current(A)	16	32	
pole	3		
dimension(mm)	a	74	91
	b	70	88
	c	70	70
	d	70	70
	e	55	55
	f	56	56
	g	56	56
	h	24	29
cable nominal cross-section area(mm ²)	1-2.5	2.5-6	

工业用暗装插座 Hide direct socket



SF-313-4 SF-323-4



SF-235 SF-245

earth contact position	6h		
rated current(A)	63	125	
pole	5		
dimension(mm)	a	240	303
	b	115	128
	c	16-38	30-50
	d	108	120
cable nominal cross-section area(mm ²)	6-16	16-50	

电 流 Current(A): 63A. 125A
电 压 Voltage(V): 220-380V~ 3P+N+E
240-415V~
防护等级 Protection degree: IP67

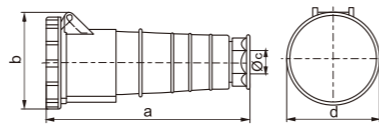

电 流 Current(A): 16A. 32A
电 压 Voltage(V): 220-240V~2P+E
防护等级 Protection degree: IP44

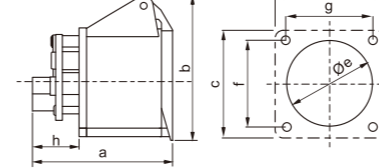

earth contact position	6h		
rated current(A)	16	32	
pole	3		
dimension(mm)	a	74	91
	b	70	88
	c	70	70
	d	70	70
	e	55	55
	f	56	56
	g	56	56
	h	24	29
cable nominal cross-section area(mm ²)	1-2.5	2.5-6	



SF-313 SF-323

电缆保护连接器 Cable sheath connector



SF-213L-4 SF-223L-4

earth contact position	4h		
rated current(A)	16	32	
pole	3		
dimension(mm)	a	150	189
	b	68	92
	c	50	65
	Ø	8	10
cable nominal cross-section area(mm ²)	1-2.5	2.5-6	

电 流 Current(A): 16A. 32A
电 压 Voltage(V): 110-130V~2P+E
防护等级 Protection degree: IP44

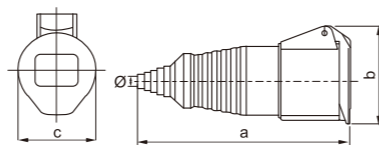

电 流 Current(A): 16A. 32A
电 压 Voltage(V): 380-415V~3P+E
防护等级 Protection degree: IP44

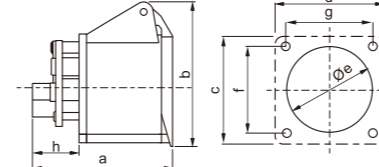

earth contact position	6h		
rated current(A)	16	32	
pole	4		
dimension(mm)	a	76	90
	b	80	87
	c	70	70
	d	70	70
	e	55	55
	f	56	56
	g	56	56
	h	25	30
cable nominal cross-section area(mm ²)	1-2.5	2.5-6	



SF-314 SF-324



SF-315 SF-325

earth contact position	6h	
rated current(A)	16	32
	pole 5	
dimension(mm)	a	93
	b	86
	c	70
	d	70
	e	55
	f	56
	g	56
	h	26
	i	28
cable nominal cross-section area(mm ²)	1-2.5	2.5-6

电 流 Current(A): 16A. 32A
电 压 Voltage(V): 220-380V~ 3P+N+E
防护等级 Protection degree: IP44

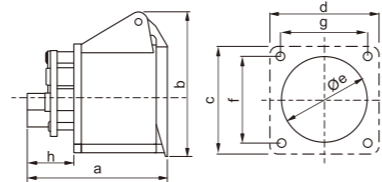

电 流 Current(A): 16A. 32A
电 压 Voltage(V): 380-415V~3P+E
防护等级 Protection degree: IP44

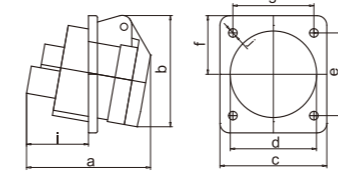

earth contact position	6h	
rated current(A)	16	32
	pole 4	
dimension(mm)	a	87
	b	80
	c	76
	d	61
	e	62
	f	42
	g	60
	i	61
	j	44
	k	5
cable nominal cross-section area(mm ²)	1-2.5	2.5-6



SF-414 SF-424



SF-333 SF-343

earth contact position	6h	
rated current(A)	63	125
	pole 3	
dimension(mm)	a	120
	b	100
	c	80
	d	80
	e	54.5
	f	88
	g	114
	h	108
	i	75
	j	90
cable nominal cross-section area(mm ²)	6-25	25-70

电 流 Current(A): 63A. 125A
电 压 Voltage(V): 220-240V~2P+E
防护等级 Protection degree: IP67

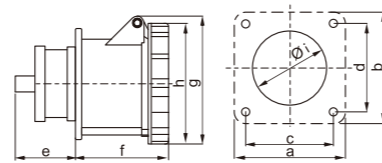

电 流 Current(A): 16A. 32A
电 压 Voltage(V): 220-380V~ 3P+N+E
防护等级 Protection degree: IP44

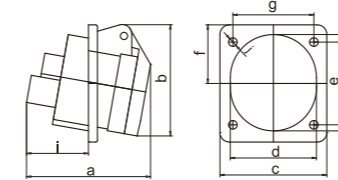

earth contact position	6h	
rated current(A)	16	32
	pole 5	
dimension(mm)	a	87
	b	79
	c	75
	d	68
	e	62
	f	37
	g	60
	h	68
	i	42
	j	5
cable nominal cross-section area(mm ²)	1-2.5	2.5-6



SF-415 SF-425



SF-334 SF-344

earth contact position	6h	
rated current(A)	63	125
	pole 4	
dimension(mm)	a	120
	b	100
	c	80
	d	80
	e	54.5
	f	88
	g	114
	h	108
	i	75
	j	90
cable nominal cross-section area(mm ²)	6-25	25-70

电 流 Current(A): 63A. 125A
电 压 Voltage(V): 380-415V~3P+E
防护等级 Protection degree: IP67

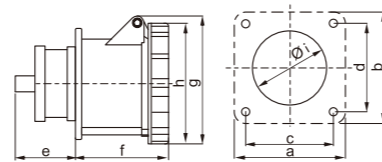

电 流 Current(A): 63A. 125A
电 压 Voltage(V): 220-240V~2P+E
防护等级 Protection degree: IP67

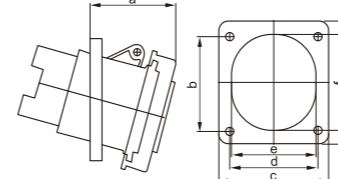

earth contact position	6h	
rated current(A)	63	125
	pole 3	
dimension(mm)	a	80
	b	89
	c	101
	d	81
	e	80.5
	f	92.2
	g	113
cable nominal cross-section area(mm ²)	6-25	16-50



SF-433 SF-443



SF-335 SF-345

earth contact position	6h	
rated current(A)	63	125
	pole 5	
dimension(mm)	a	120
	b	100
	c	80
	d	80
	e	54.5
	f	88
	g	114
	h	108
	i	75
	j	90
cable nominal cross-section area(mm ²)	6-25	25-70

电 流 Current(A): 63A. 125A
电 压 Voltage(V): 220-380V~ 3P+N+E
防护等级 Protection degree: IP67

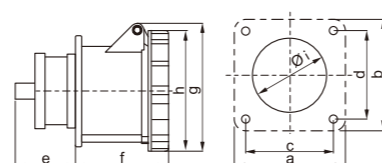

电 流 Current(A): 63A. 125A
电 压 Voltage(V): 380-415V~3P+E
防护等级 Protection degree: IP67

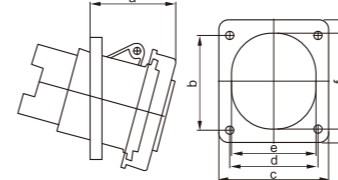

earth contact position	6h	
rated current(A)	63	125
	pole 4	
dimension(mm)	a	80
	b	89
	c	101
	d	81
	e	80.5
	f	92.2
	g	113
cable nominal cross-section area(mm ²)	6-25	16-50



SF-434 SF-444

工业用暗装插座 Hide inclined socket



SF-413-4 SF-423-4

earth contact position	4h	
rated current(A)	16	32
	pole 3	
dimension(mm)	a	87
	b	70
	c	62
	d	54
	e	49
	f	33
	g	47
	i	36
	j	5
cable nominal cross-section area(mm ²)	1-2.5	2.5-6

电 流 Current(A): 16A. 32A
电 压 Voltage(V): 110-130V~2P+E
防护等级 Protection degree: IP44

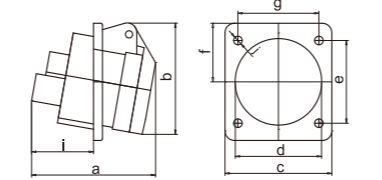

电 流 Current(A): 63A. 125A
电 压 Voltage(V): 220-380V~ 3P+N+E
防护等级 Protection degree: IP67

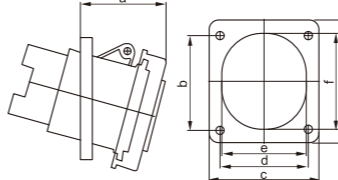

earth contact position	6h	
rated current(A)	63	125
	pole 5	
dimension(mm)	a	80
	b	89
	c	101
	d	81
	e	80.5
	f	92.2
	g	113
cable nominal cross-section area(mm ²)	6-25	16-50



SF-435 SF-445



SF-413 SF-423

earth contact position	6h	
rated current(A)	16	32
	pole 3	
dimension(mm)	a	87
	b	70
	c	62
	d	54
	e	49
	f	33
	g	47
	i	36
	j	5
cable nominal cross-section area(mm ²)	1-2.5	2.5-6

电 流 Current(A): 16A. 32A
电 压 Voltage(V): 220-240V~2P+E
防护等级 Protection degree: IP44

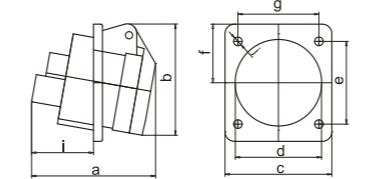

电 流 Current(A): 16A. 32A
电 压 Voltage(V): 110-130V~2P+E
防护等级 Protection degree: IP44

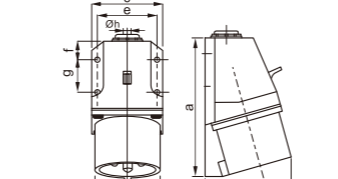

earth contact position	4h	
rated current(A)	16	32
	pole 3	
dimension(mm)	a	148
	b	80
	c	71
	d	43.5
	e	57
	f	20
	g	32.5
	h	6.5
cable nominal cross-section area(mm ²)	1-2.5	2.5-6

器具插座 Implement socket



SF-513-4 SF-523-4



SF-513 SF-523

earth contact position	6h	
rated current(A)	16	32
	pole 3	
dimension(mm)	a	134
	b	80
	c	71
	d	43.5
	e	57
	f	20
	g	32.5
	h	6.5
cable nominal cross-section area(mm ²)	1-2.5	2.5-6

电 流 Current(A): 16A. 32A
电 压 Voltage(V): 220-240V~2P+E
防护等级 Protection degree: IP44

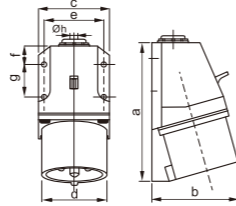

SF-514 SF-524

earth contact position	6h	
rated current(A)	16	32
	pole 4	
dimension(mm)	a	139
	b	80
	c	71
	d	50
	e	57
	f	20
	g	32.5
	h	6.5
cable nominal cross-section area(mm ²)	1-2.5	2.5-6

电 流 Current(A): 16A. 32A
电 压 Voltage(V): 380-415V~3P+E
防护等级 Protection degree: IP44

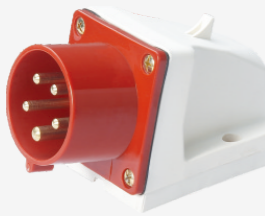
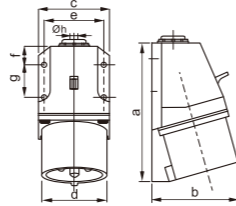

SF-515 SF-525

earth contact position	6h	
rated current(A)	16	32
	Pole 5	
dimension(mm)	a	138.5
	b	83
	c	71
	d	55
	e	57
	f	20
	g	32.5
	h	6.5
cable nominal cross-section area(mm ²)	1-2.5	2.5-6

电 流 Current(A): 16A. 32A
电 压 Voltage(V): 220-380V~240-415V~3P+N+E
防护等级 Protection degree: IP44

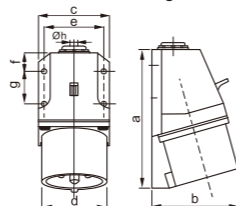

暗装器具插头 Implement plug



SF-613 SF-623

earth contact position	6h	
rated current(A)	16	32
	pole 3	
dimension(mm)	a	56
	b	56
	c	70.5
	d	70.5
	e	45
	f	23
	g	42
cable nominal cross-section area(mm ²)	1-2.5	2.5-6

电 流 Current(A): 16A. 32A
电 压 Voltage(V): 220-240V~2P+E
防护等级 Protection degree: IP44

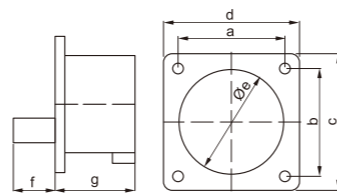

SF-614 SF-624

earth contact position	6h	
rated current(A)	16	32
	pole 4	
dimension(mm)	a	56
	b	56
	c	70.5
	d	70.5
	e	42
	f	23
	g	42
cable nominal cross-section area(mm ²)	1-2.5	2.5-6

电 流 Current(A): 16A. 32A
电 压 Voltage(V): 380-415V~3P+E
防护等级 Protection degree: IP44

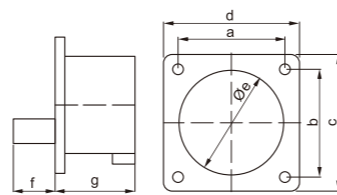

SF-615 SF-625

earth contact position	6h	
rated current(A)	16	32
	pole 5	
dimension(mm)	a	56
	b	56
	c	70.5
	d	70.5
	e	57
	f	23
	g	42
cable nominal cross-section area(mm ²)	1-2.5	2.5-6

电 流 Current(A): 16A. 32A
电 压 Voltage(V): 220-380V~240-415V~3P+N+E
防护等级 Protection degree: IP44

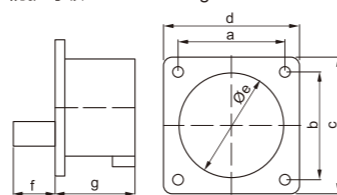

多功能插座 Multifunctional socket



型号 Code: SF-1012-4
输入 1 plug 16A Input: 110V 2P+E
输出 2 Connector Output: 16A 110V 2P+E
防护等级 Protection degree: IP44
颜色 Color: Yellow



型号 Code: SFN-1013-4
输入 1 plug 16A Input: 110V 2P+E
输出 3 Connector Output: 16A 110V 2P+E
防护等级 Protection degree: IP44
颜色 Color: Yellow



型号 Code: SF-1012
输入 1 plug 16A Input: 220V 2P+E
输出 2 Connector Output: 16A 220V 2P+E
防护等级 Protection degree: IP44
颜色 Color: Blue



型号 Code: SFN-1013
输入 1 plug 16A Input: 220V 2P+E
输出 3 Connector Output: 16A 220V 2P+E
防护等级 Protection degree: IP44
颜色 Color: Blue



型号 Code: SF-1012/4
输入 1 plug 16A Input: 380V 3P+E
输出 2 Connector Output: 16A 380V 3P+E
防护等级 Protection degree: IP44
颜色 Color: Red



型号 Code: SFN-10132-4
输入 1 plug 16A Input: 110V 2P+E
输出 3 Connector Output: 16A 110V 2P+E
防护等级 Protection degree: IP67
颜色 Color: Yellow



型号 Code: SF-1013-4
输入 1 plug 16A Input: 110V 2P+E
输出 3 Connector Output: 16A 110V 2P+E
防护等级 Protection degree: IP44
颜色 Color: Yellow



型号 Code: SFN-10132
输入 1 plug 16A Input: 220V 2P+E
输出 3 Connector Output: 16A 220V 2P+E
防护等级 Protection degree: IP67
颜色 Color: Blue



型号 Code: SF-1013
输入 1 plug 16A Input: 220V 2P+E
输出 3 Connector Output: 16A 220V 2P+E
防护等级 Protection degree: IP44
颜色 Color: Blue



型号 Code: SF-1023
输入 1 plug 32A Input: 220V 2P+E
输出 3 Connector Output: 32A 220V 2P+E
防护等级 Protection degree: IP44
颜色 Color: Blue



型号 Code: SF-1014/214
输入 1 plug 16A Input: 380V 3P+E
输出 3 Connector Output: 16A 380V 3P+E
防护等级 Protection degree: IP44
颜色 Color: Red



型号 Code: SF-1024/224
输入 1 plug 32A Input: 380V 3P+E
输出 3 Connector Output: 32A 380V 3P+E
防护等级 Protection degree: IP44
颜色 Color: Red



电流
Nominal current(A): 16A
型号
Code: SFN-10132/0132
输入
Input: 1 plug 220V 2P+E
输出
Output: 3 connector 220V 2P+E
防护等级
Protection degree: IP67

四极插头、插座
Four poles plug socket



电流
Nominal current(A): 16A
电压
Nominal voltage(V): 380V
极数
No. poles: 3P+E
型号
Code: SF-164P
SF-164S
防护等级
Protection degree: IP44

电 流 Current(A): 16A/10-16A
电 压 Voltage(V): 200-250V~2P+E
防护等级 Protection degree: IP20

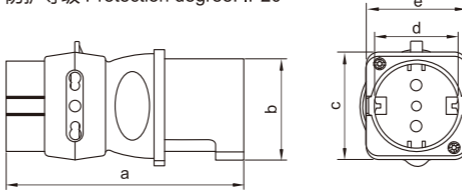

earth contact position	6h	
	pole	2P+E
dimension(mm)	a	111
	b	47
	c	50
	d	47
	e	39
cable nominal cross-section area(mm ²)	1-1.5	



SF-1312



电流
Nominal current(A): 16A
型号
Code: SFN-013/213
输入
Input: 1 plug 220V 2P+E
输出
Output: 1 connector 220V 2P+E
防护等级
Protection degree: IP44



电流
Nominal current(A): 15A
电压
Nominal voltage(V): 220V-240V~
极数
No. poles: 2P+E
型号
Code: SF-203S
防护等级
Protection degree: IP44

电 流 Current(A): 16A/10-16A
电 压 Voltage(V): 100-130V~2P+E
防护等级 Protection degree: IP20

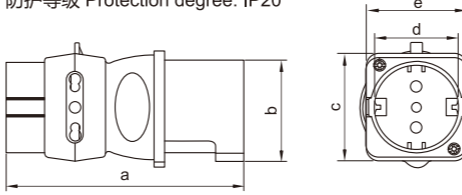

earth contact position	4h	
	pole	2P+E
dimension(mm)	a	111
	b	47
	c	50
	d	47
	e	39
cable nominal cross-section area(mm ²)	1-1.5	



SF-1312-4



电流
Nominal current(A): 16A
型号
Code: SFN-0132/2132
输入
Input: 1 plug 220V 2P+E
输出
Output: 1 connector 220V 2P+E
防护等级
Protection degree: IP67



电流
Nominal current(A): 16A
电压
Nominal voltage(V): 220-240V~
极数
No. poles: 7P+E
型号
Code: SF-018
防护等级
Protection degree: IP44

电 流 Current(A): 16A/10-16A
电 压 Voltage(V): 200-250V~2P+E
防护等级 Protection degree: IP20

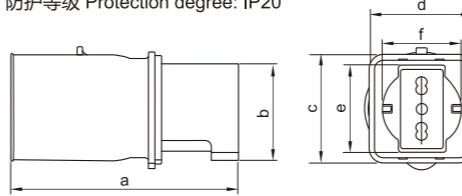

earth contact position	6h	
	pole	2P+E
dimension(mm)	a	111
	b	47
	c	54
	d	51
	e	43
	f	38
	cable nominal cross-section area(mm ²)	1-1.5



SF-7781



电流
Nominal current(A): 16A
型号
Code: SF-213/012
输入
Input: 1 plug 220V 2P+E
输出
Output: 1 connector 220V 2P+E
防护等级
Protection degree: IP44



电流
Nominal current(A): 16A
电压
Nominal voltage(V): 220-240V~
极数
No. poles: 7P+E
型号
Code: SF-118
防护等级
Protection degree: IP44

电 流 Current(A): 16A/10-16A
电 压 Voltage(V): 200-250V~2P+E
防护等级 Protection degree: IP20

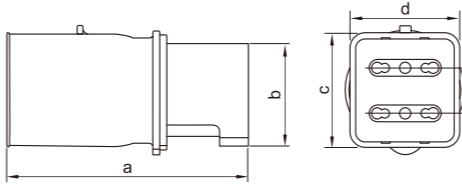

earth contact position	6h	
	pole	2P+E
dimension(mm)	a	111
	b	47
	c	54
	d	51
	e	21
cable nominal cross-section area(mm ²)	1-1.5	



SF-7782



电流
Nominal current(A): 16A
型号
Code: SF-1313
输入
Input: 1 plug 220V 2P+E
输出
Output: 1 connector 220V 2P+E
防护等级
Protection degree: IP44



电流
Nominal current(A): 16A
电压
Nominal voltage(V): 220-240V~
极数
No. poles: 8P+E
型号
Code: SF-019
防护等级
Protection degree: IP44

电 流 Current(A): 16A/10-16A
电 压 Voltage(V): 100-130V~2P+E
防护等级 Protection degree: IP20

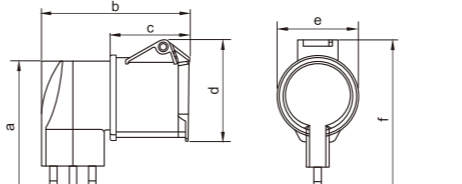

earth contact position	4h	
	pole	2P+E
dimension(mm)	a	91
	b	100
	c	54
	d	69
	e	55
	f	106
cable nominal cross-section area(mm ²)	1-1.5	



SF-7300-4



电流
Nominal current(A): 16A
电压
Nominal voltage(V): 220-240V~
极数
No. poles: 2P+E
型号
Code: SFN-213/012
防护等级
Protection degree: IP44



电流
Nominal current(A): 16A
电压
Nominal voltage(V): 220-240V~
极数
No. poles: 8P+E
型号
Code: SF-119
防护等级
Protection degree: IP44

电 流 Current(A): 16A/10-16A
电 压 Voltage(V): 200-250V~2P+E
防护等级 Protection degree: IP20

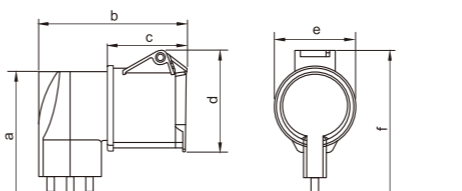

earth contact position	6h	
	pole	2P+E
dimension(mm)	a	91
	b	100
	c	54
	d	69
	e	55
	f	106
cable nominal cross-section area(mm ²)	1-1.5	



SF-7300



earth contact position	6h	
rated current(A)	16	32
pole	3	
dimension(mm)	a	105
	b	92
	φ	3-18
cable nominal cross-section area(mm ²)	1-2.5	2.5-6

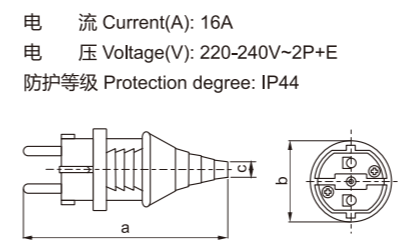
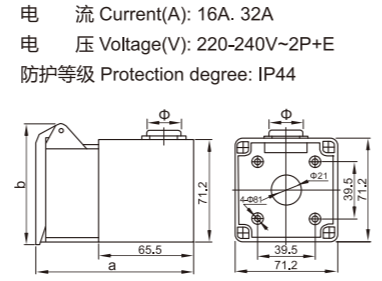

pole	3
dimension(mm)	a
	b
	c
cable nominal cross-section area(mm ²)	1-2.5



earth contact position	6h	
rated current(A)	16	32
pole	4	
dimension(mm)	a	107
	b	95
	φ	3-18
cable nominal cross-section area(mm ²)	1-2.5	2.5-6

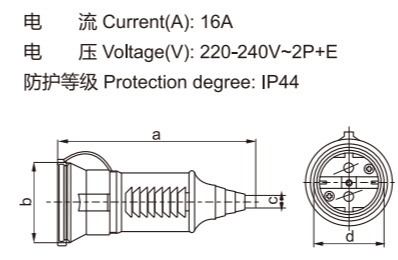
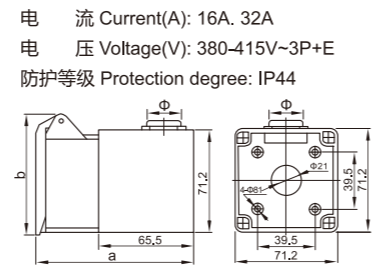

pole	3
dimension(mm)	a
	b
	c
	d
cable nominal cross-section area(mm ²)	1-2.5



earth contact position	6h	
rated current(A)	16	32
pole	5	
dimension(mm)	a	110
	b	96
	φ	3-18
cable nominal cross-section area(mm ²)	1-2.5	2.5-6

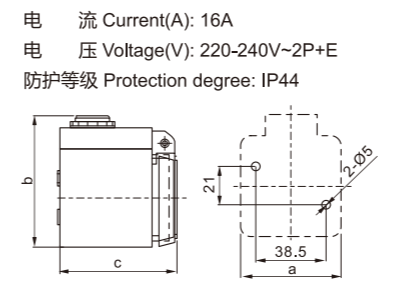
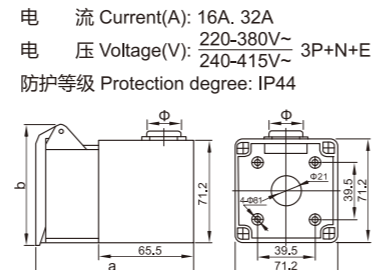

pole	3
dimension(mm)	a
	b
	c
cable nominal cross-section area(mm ²)	1-2.5



earth contact position	6h	
rated current(A)	16	32
pole	3	
dimension(mm)	a	125
	b	88
	c	46.5
	d	52
cable nominal cross-section area(mm ²)	1-2.5	2.5-6

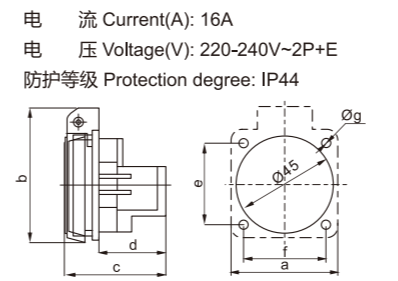
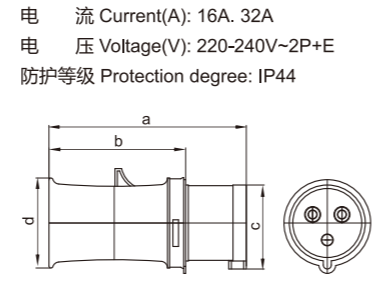

pole	3
dimension(mm)	a
	b
	c
	d
	e
	f
	g
cable nominal cross-section area(mm ²)	1-2.5



earth contact position	6h	
rated current(A)	16	32
pole	4	
dimension(mm)	a	130
	b	93
	c	53
	d	58
cable nominal cross-section area(mm ²)	1-2.5	2.5-6

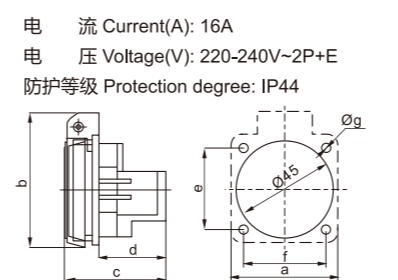
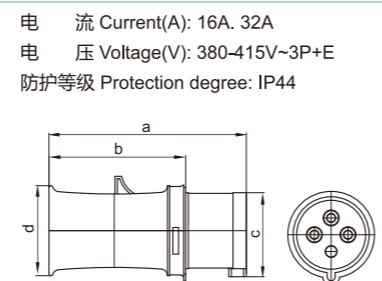

pole	3
dimension(mm)	a
	b
	c
	d
	e
	f
	g
cable nominal cross-section area(mm ²)	1-2.5



earth contact position	6h	
rated current(A)	16	32
pole	5	
dimension(mm)	a	135
	b	98
	c	60
	d	66
cable nominal cross-section area(mm ²)	1-2.5	2.5-6

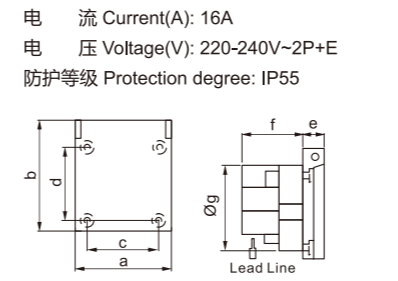
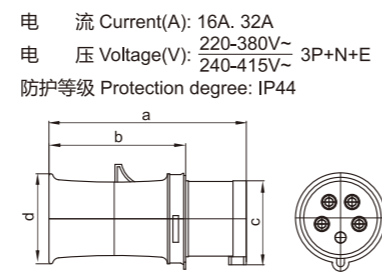

pole	3
dimension(mm)	a
	b
	c
	d
	e
	f
	g
cable nominal cross-section area(mm ²)	1-2.5



二极多功能插座
Two-poles multi-socket



电流
Nominal current(A): 16A
电压
Nominal voltage(V): 220-240V
极数
No. poles: 2P+E
型号
Code: SFN-312M
防护等级
Protection degree: IP55

二极多功能插座
Two-poles multi-socket



电流
Nominal current(A): 16A
电压
Nominal voltage(V): 220-240V
极数
No. poles: 2P+E
型号
Code: SFN-312K
防护等级
Protection degree: IP55

发电机插头.插座
Generator plug. Socket



电流
Nominal current(A): 15A
电压
Nominal voltage(V): 220V-240V~
极数
No. poles: 2P+E
型号
Code: SF-203P
防护等级
Protection degree: IP44

防水插头
Waterproof Socket



电流
Nominal current(A): 10A, 15A
电压
Nominal voltage(V): 220-240V
极数
No. poles: 2P+E
型号
Code: SF-56010P, SF-56015P
防护等级
Protection degree: IP66

二极多功能插座
Two-poles multi-socket



电流
Nominal current(A): 30A
电压
Nominal voltage(V): 220V-240V~
极数
No. poles: 2P+E
型号
Code: SF-303P
防护等级
Protection degree: IP44

二极多功能插座
Two-poles multi-socket



电流
Nominal current(A): 30A
电压
Nominal voltage(V): 220V-240V
极数
No. poles: 2P+E
型号
Code: SF-023P
防护等级
Protection degree: IP44

二极多功能插座
Two-poles multi-socket



电流
Nominal current(A): 30A
电压
Nominal voltage(V): 220V-240V~
极数
No. poles: 2P+E
型号
Code: SF-303S-2
防护等级
Protection degree: IP44

二极多功能插座
Two-poles multi-socket



电流
Nominal current(A): 30A
电压
Nominal voltage(V): 220V-240V
极数
No. poles: 2P+E
型号
Code: SF-123S
防护等级
Protection degree: IP44

二极多功能插座
Two-poles multi-socket



电流
Nominal current(A): 30A
电压
Nominal voltage(V): 220V-240V~
极数
No. poles: 2P+E
型号
Code: SF-303S
防护等级
Protection degree: IP44

三极多功能插座
Three-poles multi-socket



电流
Nominal current(A): 30A
电压
Nominal voltage(V): 380V~
极数
No. poles: 3P+E
型号
Code: SF-024P
防护等级
Protection degree: IP44

二极多功能插座
Two-poles multi-socket



电流
Nominal current(A): 30A
电压
Nominal voltage(V): 220V-240V~
极数
No. poles: 2P+E
型号
Code: SF-303S-1
防护等级
Protection degree: IP44

三极多功能插座
Three-poles multi-socket



电流
Nominal current(A): 30A
电压
Nominal voltage(V): 380~
极数
No. poles: 3P+E
型号
Code: SF-124S
防护等级
Protection degree: IP44

电 流 Current(A): 10A, 16A
电 压 Voltage(V): 220-240V
防护等级 Protection degree: IP66

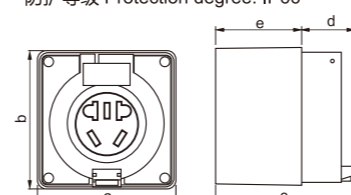

model	SF-56510F	SF-56516F
pole	1P+N+PE	1P+N+PE
dimension(mm)	a	100
	b	100
	c	100/78
	d	38
	e	60/37

民用防水插座 Waterproof load isolation switch



SF-56510F SF-56516F

电 流 Current(A): 10A, 15A
电 压 Voltage(V): 220-240V
防护等级 Protection degree: IP66

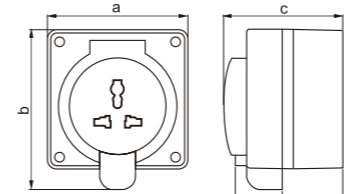

model	SF-56310S	SF-56315S
pole	1P+N+PE	1P+N+PE
dimension(mm)	a	100
	b	116
	c	100/78
	d	46
	e	60/37

多功能防水插座 Waterproof load isolation switch



SF-56310S SF-56315S

电 流 Current(A): 16-80A
电 压 Voltage(V): 380-415V~3P+E
防护等级 Protection degree: IP44

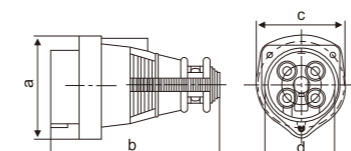

rated current(A)		16-25	32-80
	pole	4	
dimension(mm)	a	72	85.5
	b	102	140
	c	63	75
	d	47	61

橡胶插头 Latex plug



SF-204P (-204P,-404P,-804P)

电 流 Current(A): 10-80A
电 压 Voltage(V): 220-415V~3P+N+E
防护等级 Protection degree: IP44

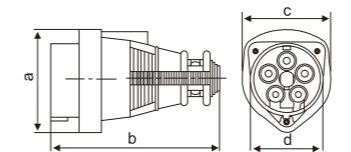

rated current(A)		16-25	32-80
	pole	5	
dimension(mm)	a	72	85.5
	b	102	140
	c	63	75
	d	47	61

橡胶插座 Latex socket



SF-205P (-205P,-405P,-805P)

电 流 Current(A): 16-80A
电 压 Voltage(V): 380-415V~3P+E
防护等级 Protection degree: IP44

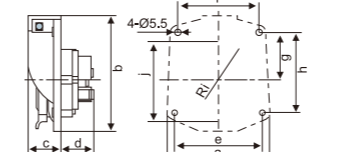

rated current(A)		16-25	32-80
	pole	4	
dimension(mm)	a	88	105
	b	99	116
	c	28	32
	d	27	38
	e	75	91.6
	f	70	86
	g	40.5	43.5
	h	68.5	80.5
	i	33	35
	j	68.5	80

橡胶插座 Latex socket



SF-204S (-204S,-404S,-804S)

电 流 Current(A): 10-80A
电 压 Voltage(V): 220-415V~3P+N+E
防护等级 Protection degree: IP44

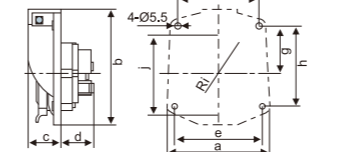

rated current(A)		16-25	32-80
	pole	5	
dimension(mm)	a	88	105
	b	99	116
	c	28	32
	d	27	38
	e	75	91.6
	f	70	86
	g	40.5	43.5
	h	68.5	80.5
	i	33	35
	j	68.5	80

橡胶插座 Latex socket



SF-205S (-205S,-405S,-805S)

箱体可根据客户需要定制或内加装其它电器附件
Box can be equipped with others electrical accessories as preferred



透明保护罩：防水、防尘
符合标准
Executive standard: IEC60529 IP67
产品规格：SF-2窗口

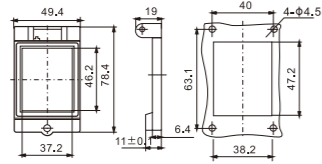

透明保护罩：防水、防尘
符合标准
Executive standard: IEC60529 IP67
产品规格：SF-12窗口

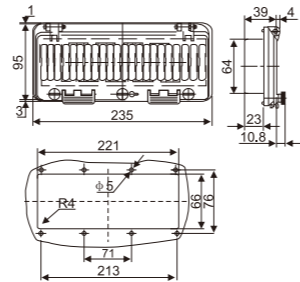

箱体可根据客户需要定制或内加装其它电器附件
Box can be equipped with others electrical accessories as preferred



移动式插座箱

箱体尺寸: 340×370×330mm

- SFN-312 4只
- SFN-325 2只
- SFN-315 2只
- DZ47-16/1 4只
- DZ47-16/3 2只
- DZ47-32/3 2只
- DZ47-60/3 1只



移动式插座箱

箱体尺寸: 340×370×330mm

- SFN-3132 6只
- SFN-3232 2只
- SFN-0352 1只
- CDB3LE-16 6只
- CDB3LE-32 2只
- DZ47-100/4 1只



透明保护罩：防水、防尘
符合标准
Executive standard: IEC60309 IP67
产品规格：SF-4窗口

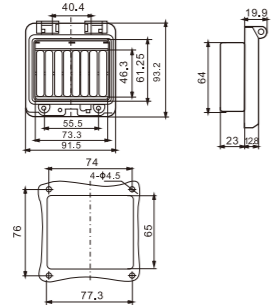

壳体尺寸: 390×250×270mm

- SFN-3152 2只
- SFN-325 1只
- SFN-323 1只
- DZ47: 3P 32A 1只
- DZ47: 3P 63A 1只
- DZ47: 3P 63A漏电 1只



移动式插座箱

箱体尺寸: 300×230×287MM

- SFN-3232 4只
- DZ47-32/2 4只
- DZ47-60/4 1只



移动式插座箱

箱体尺寸: 230×300×287mm

- SFN-315 4只
- SFN-312 4只
- SFN-025 1只
- DZ47-20/1 1只
- DZ47-32/3 2只
- DZ47-60/3 1只



透明保护罩：防水、防尘
符合标准
Executive standard: IEC60309 IP67
产品规格：SF-6窗口

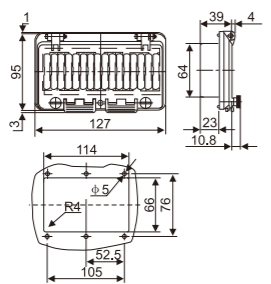

壳体尺寸: 420×420×500mm

- SF-312 3只
- SFN-314 3只
- SFN-3152 2只
- SFN-313 3只
- DZ47: 3P 32A 1只
- DZ47: 1P 16A 3只
- DZ47: 3P 40A 1只
- DZ47: 2P 16A 3只



移动式插座箱

壳体尺寸: 300×230×287mm

- SFN-312 3只
- SFN-314 2只
- SFN-615 1只
- DZ47-16/1 3只
- DZ47-16/3 2只
- DZ47-32/3 1只



移动式插座箱

壳体尺寸: 230×300×287mm

- SFN-315 2只
- SF-312 4只
- SFN-313 2只
- DZ47: 2P 32A 1只
- DZ47: 2P 40A 1只
- DZ47: 4P 60A 1只
- DZ47: 3P 32A 1只
- DZ47: 1P 20A 2只



透明保护罩：防水、防尘
符合标准
Executive standard: IEC60309 IP67
产品规格：SF-8窗口

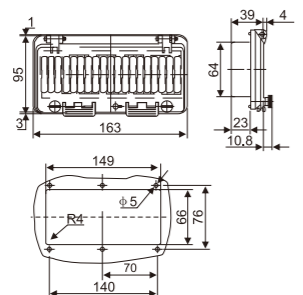

壳体尺寸: 380×380×520mm

- 指示灯: 220V 3只
- SFN-6352 1只
- SFN-3132 3只
- SFN-3252 1只
- SF-56510 3只
- 86型10A三孔插座 3只
- DZ47-60A/4 1只
- DZ47LE-32/3+N 1只
- DZ47LE-16A/1+N 3只
- DZ47LE-10A/1+N 6只



移动式插座箱

壳体尺寸: 340×370×330mm

- SFN-312 10只
- SFN-3152 6只
- SFN-0352 1只
- DZ47-16/1 5只
- DZ47-16/3 6只



移动式插座箱

壳体尺寸: 230×300×287mm

- SFN-315 2只
- SFN-313 2只
- SF-312 1只
- DZ47: 2P 32A 2只
- DZ47: 4P 32A 1只

箱体可根据客户要求定制或内加装其它电器附件
Box can be equipped with others electrical accessories as preferred



手提式插座箱1805

- 壳体尺寸: 430×140×95mm
- SF-312 6只
- DZ47: 16/1 6只

手提式插座箱1805

- 壳体尺寸: 430×140×95mm
- SF-313 3只
- DZ47LE-40/1 1只
- DZ47-16/1 3只

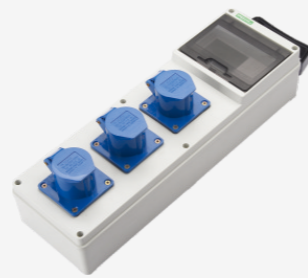

箱体可根据客户要求定制或内加装其它电器附件
Box can be equipped with others electrical accessories as preferred



手提式插座箱1805

- 壳体尺寸: 430×140×95mm
- SFN-3132 3只
- CDB3LE-40 1只
- DZ47-16/1P 3只

手提式插座箱1805

- 壳体尺寸: 430×140×95mm
- SF-312 2只
- SFN-323 1只
- DZ47: 2P 16A 2只
- DZ47: 2P 32A 1只

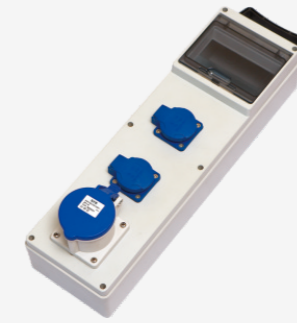

手提式插座箱1805

- 壳体尺寸: 430×140×95mm
- SF-413 3只
- SFN-013 1只
- DZ47-40/2 1只
- DZ47-16/1 3只
- 电线: 3x2.5² 5米

手提式插座箱1805

- 壳体尺寸: 430×140×95mm
- SFN-3152 3只
- DZ47: 4P 50A 1只



手提式插座箱1805-2

- 壳体尺寸: 430×140×95mm
- SFN-312 8只
- DZ47-20 3只

手提式插座箱1805-2

- 壳体尺寸: 430×140×95mm
- SFN-312 2只
- SFN-3142 2只
- DZ47: 32/3P 1只
- DZ47: 16/1P 2只

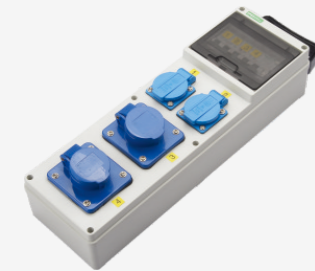

手提式插座箱1805

- 壳体尺寸: 430×140×95mm
- SF-413 2只
- SF-312 2只
- DZ47-16/1: 2只
- CDB3LE-60: 1只

手提式插座箱1805

- 壳体尺寸: 430×140×95mm
- SF-413 3只
- CDB3LE-40 1只
- DZ47-16/1 3只



手提式插座箱1805-2

- 壳体尺寸: 430×140×95mm
- SFN-415 3只
- DZ47-32/3 1只
- DZ47-16/3 1只

手提式电源插座箱1805-2

- 箱体尺寸: 490×140×95mm
- SFN-3232 3只
- DZ47LE-40/3 1只
- 电线: 5x4² 3米



手提式插座箱1805

- 壳体尺寸: 430×140×95mm
- SFN-4132 3只
- DZ47: 2P 16A 3只

手提式插座箱1805

- 壳体尺寸: 430×140×95mm
- SF-413-4 4只
- DZ47: 1P 16A 4只



手提式插座箱1805

- 壳体尺寸: 430×140×95mm
- SF-313 2只
- SF-013 1只
- 电线1.5mm² 30m
- DZ47LE-32/1 1只
- DZ47-16/1 2只

手提式插座箱1805

- 壳体尺寸: 430×140×95mm
- SF-314 2只
- SF-014 1只
- DZ47: 3P 16A 2只
- 电线1.5mm² 30m



箱体可根据客户需要定制或内加装其它电器附件
Box can be equipped with others electrical accessories as preferred



电源插座箱

箱体尺寸: 150×250×100mm

SFN-312 2只

DZ47-16/1 2只

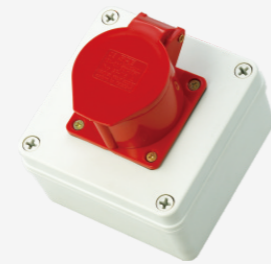

电源插座箱

壳体尺寸: 125×125×75mm

SF-315 1只



电源插座箱

箱体尺寸: 250×150×100mm

SFN-315 2只

SFN-325 1只



电源插座箱

壳体尺寸: 250×150×100mm

SF-315 1只

DZ47: 4P 16A 1只



电源插座箱

箱体尺寸: 250×150×100mm

SFN-4132 2只



电源插座箱

壳体尺寸: 340×220×150mm

SF-335 1只

SF-313 2只



手提式插座箱

箱体尺寸: 260×170×140mm

SFN-4131 2只

SF-013 1只

DZ47LE-16/1 2只

电线3x2.5² 5米



电源插座箱

壳体尺寸: 400×300×160mm

SFN-4352 1只

SFN-4132 1只

DZ47: 4P 63A 1只

DZ47: 2P 16A 1只

箱体可根据客户需要定制或内加装其它电器附件
Box can be equipped with others electrical accessories as preferred



手提式插座箱

壳体尺寸: 260×170×140mm

SFN-313 2只

DZ47: 2P 16A 2只



电源插座箱

壳体尺寸: 260×170×140mm

SF-335 1只

DZ47: 4P 63A 1只



手提式插座箱

壳体尺寸: 260×170×140mm

SFN-315 2只

DZ47: 4P 16A 2只

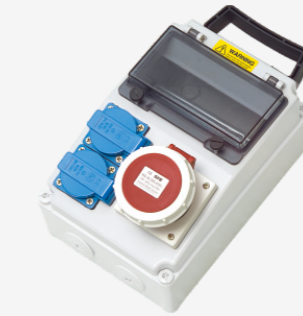

手提式插座箱

壳体尺寸: 260×170×140mm

SFN-3152 1只

SF-312 2只

DZ47: 4P 16A 1只

DZ47: 2P 16A 2只



手提式插座箱

壳体尺寸: 260×170×140mm

SFN-3132 2只

DZ47LE-16/2 2只



电源插座箱

壳体尺寸: 280×220×125mm

SF-313 1只

SF-315 1只

DZ47: 2P 16A 1只

DZ47: 4P 16A 1只



电源插座箱

壳体尺寸: 250×220×125mm

SFN-315 1只

SFN-313 1只

DZ47: 2P 16A 1只

DZ47: 4P 16A 1只



电源插座箱

壳体尺寸: 280×220×125mm

SFN-313 1只

SFN-314 1只

DZ47: 2P 16A 1只

DZ47: 4P 16A 1只

箱体可根据客户需要定制或内加装其它电器附件
Box can be equipped with others electrical accessories as preferred



电源插座箱

壳体尺寸: 540×360×180mm

SFN-313	4只
SFN-324	3只
SFN-323	1只
DZ47LE-60/4	1只
DZ47-32/3P	3只
DZ47-16/1P	4只
DZ47-32/1P	1只



电源插座箱

A+B+B

SFN-3132	3只
SFN-3252	1只
NL1E-60/4	1只
DZ47-32/3	1只
DZ47-16/1	3只

电源插座箱

壳体尺寸: 400×300×160mm

SFN-313	6只
DZ47-60/4P	1只
DZ47-16/1P	6只



电源插座箱

壳体尺寸: 400×300×160mm

SFN-4242	2只
SFN-4132	3只



机械联锁插座箱

壳体尺寸: 540×360×180mm

机械联锁SFN-413	2只
机械联锁SFN-414	2只
DZ47-16/3P	2只
DZ47-16/2P	2只



电源插座箱

壳体尺寸: 540×360×180mm

SFN-3342	3只
SFN-323	2只
CDB2LE-125/4P	1只
DZ47-60/3P	3只
DZ47-32/1P	2只



电源插座箱

壳体尺寸: 540×360×180mm

SFN-3352	4只
DZ47-60/3P	4只



电源插座箱

壳体尺寸: 520×300×160mm

SF-315	3只
SF-314	4只
指示灯	1只
NL1E-40	2只
NL1E-63	1只



箱体可根据客户需要定制或内加装其它电器附件
Box can be equipped with others electrical accessories as preferred



电源插座箱

壳体尺寸: 540×360×180MM

SFN-4352	1只
SFN-4332	2只
DZ47 4P 63A	1只
DZ47LE 2P 63A	2只



电源插座箱

壳体尺寸: 250×250×100mm

SF-312	6只
--------	----



电源插座箱

壳体尺寸: 400×300×160mm

SFN-3252	2只
SF-312	3只
DZ47-32/3	2只
DZ47-16/1	3只



组合电源插座箱

A+B+B

SFN-312	2只
SFN-313	2只
SFN-314	1只
SFN-324	1只
DZ47-16/3	1只
DZ47-32/3	1只
DZ47-16/1	3只
DZ47-32/1	1只



电源插座箱

壳体尺寸: 400×300×160mm

SFN-324	2只
SFN-313	1只
DZ47LE-60/4	1只
DZ47-16/3	2只
DZ47-16/2	1只

电源插座箱

壳体尺寸: 520×300×160mm

SFN-3152	1只
SFN-3132	4只
DZ47LE-60/4P	1只
DZ47-16/3P	1只
DZ47-32/2P	1只
DZ47-16/1P	6只



电源插座箱

壳体尺寸: 560×400×200mm

SFN-4352	2只
SFN-425	2只
AC 10A 2插	1只
AC 16A 3插	1只
DZ47-60/4P	2只
DZ47-32/4P	2只



电源插座箱

箱体尺寸: 360×540×180mm

SFN-3132	2只
SFN-3242	2只
SFN-3342	2只
DZ47-16/2	2只
DZ47-32/3	2只
DZ47-60/3	2只
PZ158-125/4	1只



箱体可根据客户需要定制或内加
装其它电器附件
Box can be equipped with
others electrical accessories
as preferred



电源插座箱

壳体尺寸: 540×360×180mm	
SF-312	3只
SFN-413	1只
SFN-415	1只



组合插座箱A+B+B

SFN-313	2只
SFN-314	2只
SFN-315	1只
DZ47-16/1	2只
DZ47-16/3	2只
DZ47-32/3	1只



电源插座箱

壳体尺寸: 400×300×160mm	
SFN-313	3只
SFN-314	3只
DZ47: 2P 16A	3只
DZ47: 3P 32A	2只



电源插座箱

壳体尺寸: 520×300×160mm	
SFN-3132	1只
SFN-3142	1只
SFN-313	1只
SFN-314	1只

箱体可根据客户需要定制或内加
装其它电器附件
Box can be equipped with
others electrical accessories
as preferred



电源插座箱

箱体尺寸: 300×400×160mm	
SFN-4132	1只
SFN-4352	1只
DZ47-63/3	2只
DZ47-16/1	2只

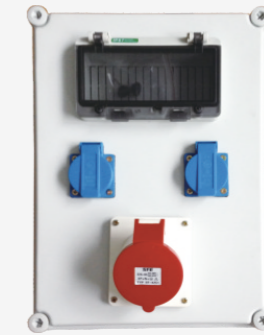

电源插座箱

箱体尺寸: 280×380×130mm	
SFN-312	2只
SFN-4251	1只
DZ47-10/1	2只
DZ47-32/3	1只



电源插座箱

壳体尺寸: 400×300×160mm	
SF-312	3只
SFN-4232	1只
SFN-4242	1只



电源插座箱

壳体尺寸: 300×400×160mm	
SF-312	3只
SFN-313	1只
SFN-314	1只
SFN-315	1只
DZ47: 2P 16A	1只
DZ47: 2P 32A	1只
DZ47: 3P 16A	1只
DZ47: 4P 16A	1只

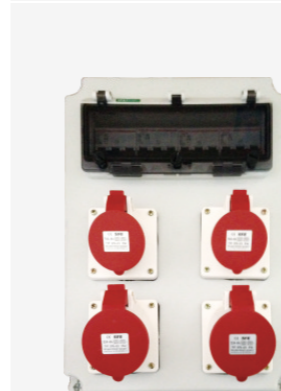

电源插座箱

箱体尺寸: 300×400×160mm	
SFN-415	2只
SFN-425	2只
DZ47-16/3	2只
DZ47-32/3	2只



电源插座箱

箱体尺寸: 300×400×160mm	
SFN-4152	3只
DZ47-16/3	3只
DZ47-60/3	1只



电源插座箱

壳体尺寸: 540×360×180mm	
SF-313	2只
SF-314	2只
SF-334	1只
DZ47: 2P 16A	2只
DZ47: 3P 16A	2只
DZ47: 3P 63A	1只
DZ47LE-60/4	1只



电源插座箱

壳体尺寸: 540×360×180mm	
SFN-313	1只
SFN-314	1只
SFN-315	1只
SFN-3332	1只
SFN-3352	1只



电源插座箱

箱体尺寸: 300×400×160mm	
SFN-312	1只
SFN-413	2只
SFN-424	2只
DZ47LE-60/4	1只
DZ47-32/1	1只
DZ47-40/3	1只



电源插座箱

箱体尺寸: 300×520×160mm	
SFN-423	2只
SFN-425	1只
DZ47-60/4	1只
DZ47LE-32/2	2只
DZ47LE-32/4	1只



电源插座箱

箱体尺寸: 300×520×160mm	
SFN-4132	2只
SFN-4242	1只
DZ47-16/1	2只
DZ47-32/3	6只



电源插座箱

箱体尺寸: 300×400×160mm	
SFN-4131	4只
SFN-4151	1只
DZ47-60/4	1只
DZ47-16/3	1只
DZ47-16/1	4只

箱体可根据客户需要定制或内加
装其它电器附件
Box can be equipped with
others electrical accessories
as preferred



电源插座箱

- 壳体尺寸: 340×220×150mm
- SFN-3132 1只
- SFN-3252 1只
- DZ47: 16A 2P 1只
- DZ47: 32A 4P 1只



电源插座箱

- 壳体尺寸: 380×280×180mm
- SFN-313 1只
- SFN-323 1只
- SFN-415 1只
- SFN-425 1只
- DZ47: 2P 16A 1只
- DZ47: 2P 32A 1只
- DZ47: 3P 16A 1只
- DZ47: 3P 32A 1只

箱体可根据客户需要定制或内加
装其它电器附件
Box can be equipped with
others electrical accessories
as preferred



电源插座箱

- 壳体尺寸: 400×300×160mm
- SFN-3132 2只
- SFN-3252 2只
- DZ47: 2P 16A 2只
- DZ47: 4P 63A 1只



电源插座箱

- 壳体尺寸: 520×300×160mm
- SFN-315 1只
- SFN-325 1只
- SFN-4352 1只
- SF-312 2只
- DZ47: 3P 63A 1只
- DZ47: 3P 32A 1只
- DZ47: 3P 16A 1只
- DZ47: 2P 16A 2只



电源插座箱

- 壳体尺寸: 220×340×150mm
- SFN-313 2只
- SFN-315 2只
- DZ47: 2P 32A 1只
- DZ47: 3P 63A 1只



电源插座箱

- 壳体尺寸: 270×460×160mm
- SF-312 2只
- SFN-415 3只
- DZ47: 3P 63A漏电 1只
- DZ47: 2P 16A 1只



电源插座箱

- 壳体尺寸: 400×300×160mm
- SF-312 2只
- SFN-415 2只
- DZ47: 2P 32A 1只
- DZ47: 3P 32A 1只
- AC模数化插座: 3插 2只
- AC模数化插座: 2插 1只



电源插座箱

- 壳体尺寸: 400×300×160mm
- SF-313 3只
- DZ47: 2P 16A 3只



电源插座箱

- 壳体尺寸: 400×300×160mm
- SF-312 4只
- SFN-3132 1只
- SFN-3152 1只
- SFN-3252 1只
- DZ47 1P 32A 3只
- 3P 16A 1只
- 3P 32A 1只
- NL1E-60/4 1只



电源插座箱

- 壳体尺寸: 300×520×160mm
- SF-312 4只
- SFN-313 1只
- SFN-315 1只
- SFN-325 1只
- DZ47: 3P 63A漏电 1只
- DZ47: 2P 32A 2只
- DZ47: 3P 32A 1只
- DZ47: 3P 16A 1只



电源插座箱

- 壳体尺寸: 520×300×160mm
- SFN-3132 2只
- SFN-335 2只
- DZ47: 3P 63A 2只
- DZ47: 2P 16A 2只
- DZ47: 3P 100A漏电 1只



电源插座箱

- 箱体尺寸: 220×340×150mm
- SFN-312 3只
- DZ47-16/1 3只



电源插座箱

- 壳体尺寸: 520×300×160mm
- SFN-3132 2只
- SFN-3252 2只
- DZ47LE: 3P 32A 漏电 1只
- DZ47: 1P 16A 2只
- DZ47: 3P 16A 1只
- DZ47: 3P 32A 1只



机械联锁箱

- 壳体尺寸: 300×520×160mm
- 机械联锁 SFN-413 1只
- 机械联锁 SFN-414 1只
- 机械联锁 SFN-415 1只

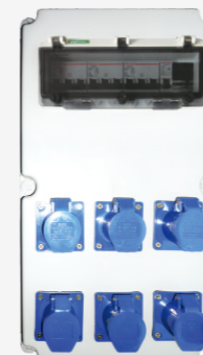

电源插座箱

- 壳体尺寸: 520×300×160mm
- SF-313 6只
- DZ47: 2P 32A 3只



电源插座箱

- 壳体尺寸: 520×300×160mm
- SFN-3132 1只
- SFN-3152 1只
- SFN-4352 1只
- DZ47: 2P 16A 1只
- DZ47: 4P 16A 1只
- DZ47: 4P 63A 1只

箱体可根据客户需要定制或内加
装其它电器附件
Box can be equipped with
others electrical accessories
as preferred



电源插座箱

箱体尺寸: 330×492×175mm
SFN-3152 3只
DZ47-16/3 3只
DZ47LE-63/4 1只



电源插座箱

箱体尺寸: 300×430×175mm
SFN-313 5只
SFN-315 4只
DZ47-16/1 3只
DZ47-32/3 2只
DZ47-63/4 1只

箱体可根据客户需要定制或内加
装其它电器附件
Box can be equipped with
others electrical accessories
as preferred



电源插座箱

箱体尺寸: 300×400×160mm
SFN-413 2只
SFN-425 1只
DZ47-16/2 2只
DZ47-32/4 1只



电源插座箱

箱体尺寸: 300×400×160mm
SFN-312 3只
SFN-314 1只
SFN-325 1只
DZ47-16/1 3只
DZ47-16/3 1只
DZ47-32/3 1只



电源插座箱

箱体尺寸: 280×342×155mm
SFN-413 4只
DZ47-16/2 4只
DZ47-63/4 1只



电源插座箱

箱体尺寸: 500×680×200mm
SFN-313 5只
SFN-315 5只
SFN-325 5只
DZ47-16/2 5只
DZ47-16/3 5只
DZ47-32/3 5只
DZ158-125/4 1只



电源插座箱

箱体尺寸: 300×400×160mm
SFN-313 3只
SFN-3252 2只
DZ47-16/1 3只
DZ47-32/3 2只
DZ47-60/3 1只



电源插座箱

箱体尺寸: 360×540×180mm
SFN-313 3只
SFN-324 2只
SFN-3342 2只
CDB2LE-100/4 1只
DZ47-16/1 3只
DZ47-32/3 2只
DZ47-60/3 2只



电源插座箱

箱体尺寸: 330×392×175mm
SFN-312 2只
SFN-415 3只
DZ47-32/1 1只
DZ47-16/3 3只
DZ47-63/1 1只



电源插座箱

箱体尺寸: 300×530×175mm
SFN-413 4只
SFN-414 3只
DZ47-16/1 4只
DZ47-16/3 3只
DZ47LE-63/4 1只



电源插座箱

箱体尺寸: 300×520×160mm
SFN-312 4只
SFN-415 2只
SFN-425 1只
DZ47LE-60/4 1只
DZ47-16/3 2只
DZ47-32/3 1只
DZ47-16/1 4只



电源插座箱

箱体尺寸: 300×520×160mm
SFN-313 3只
SFN-315 1只
SFN-325 1只



电源插座箱

箱体尺寸: 280×342×155mm
SFN-413 3只
SFN-415 3只
DZ47-16/3 2只
DZ47-16/1 3只
DZ47-63/4 1只



电源插座箱

箱体尺寸: 300×400×160mm
SFN-323 2只
SFN-3342 1只
DZ47-60/4 1只
DZ47-60/3 1只
DZ47-32/1 2只



电源插座箱

箱体尺寸: 300×400×160mm
SFN-3131 2只
SFN-3251 2只



手提电源插座箱

箱体尺寸: 300×400×160mm
SF-413 4只
SF-414 1只
NL1E-16/4 1只
CDB3LE-16 4只

箱体可根据客户需要定制或内加装其它电器附件
Box can be equipped with others electrical accessories as preferred



电源插座箱

- 箱体尺寸: 300×520×160mm
- SFN-4252 1只
- SFN-4352 2只
- CDB2-100A/3 1只
- DZ47-60/3 2只
- DZ47-32/3 1只



电源插座箱

- 箱体尺寸: 300×400×160mm
- SFN-3132 3只
- SFN-3252 3只
- DZ47-16/1 3只
- DZ47-32/3 3只

箱体可根据客户需要定制或内加装其它电器附件
Box can be equipped with others electrical accessories as preferred



电源插座箱

- 箱体尺寸: 300×400×160mm
- SFN-3132 2只
- SFN-3252 2只
- DZ47-32/3 2只
- DZ47-16/1 2只



组合电源插座箱

- A+B+B
- SFN-313 1只
- SFN-323 1只
- SFN-314 1只
- SFN-315 2只
- NL1E-60/4 1只
- DZ47-32/3 1只
- DZ47-16/3 1只
- DZ47-32/2 1只

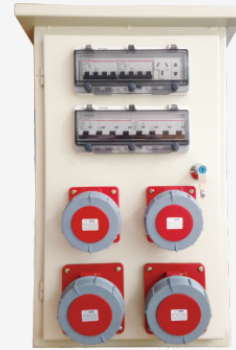

电源插座箱

- 箱体尺寸: 680×400×200mm
- SF-4352 2只
- SF-4452 2只
- AC 10A 二插 1只
- AC 16A 三插 1只
- DZ47-60/3 2只
- CDB2-100/3 2只



电源插座箱

- 箱体尺寸: 330×430×170mm
- SF-314 5只
- SF-313 1只
- DZ47-60/4 1只
- DZ47-32/3 3只



电源插座箱

- 箱体尺寸: 300×520×160mm
- SF-324 4只
- CDB2-100/3 1只
- DZ47LE-32/3 4只



组合电源插座箱

- A+B+B
- SFN-315 3只
- SFN-312 3只
- DZ47-16/3 3只
- DZ47-16/1 3只



电源插座箱

- 箱体尺寸: 300×400×160mm
- SF-325 2只
- SF-312 1只
- 多功能五孔墙壁开关 2只
- NL1E-32/4 2只
- CPB3LE-16 2只



电源插座箱

- 箱体尺寸: 330×530×170mm
- SF-314 5只
- SF-313 3只
- DZ47-16/3 5只
- DZ47-16/1 3只
- DZ47LE-60/4 1只



电源插座箱

- 箱体尺寸: 300×520×160mm
- SFN-3132 6只
- DZ47LE-60/2 1只
- DZ47-40/3 4只



电源插座箱

- 箱体尺寸: 300×400×160mm
- SFN-313 3只
- SFN-324 1只
- SFN-334 1只
- CDB2-100/3 1只
- DZ47-60/3 1只
- DZ47-32/3 1只
- DZ47-40/1 1只



电源插座箱

- 箱体尺寸: 300×400×160mm
- SFN-3252 2只
- DZ47-60/3,4 1只
- DZ47-32/2 2只
- DZ47-16/2 2只
- AC 10A 二插 1只
- AC 16A 三插 1只



电源插座箱

- 箱体尺寸: 220×340×150mm
- SFN-313 1只
- SFN-324 1只
- CDB3LE-16/1 1只
- DZ47LE-32/3 1只



电源插座箱

- 箱体尺寸: 300×400×160mm
- SF-334 2只
- SF-323 2只
- DZ158-125/3 1只
- DZ47LE-60/3 1只
- DZ47LE-32/1 1只



电源插座箱

- 箱体尺寸: 280×380×130mm
- SFN-312 3只
- SFN-424 2只
- DZ47-32/3 2只
- DZ47-16/1 2只

箱体可根据客户需要定制或内加
装其它电器附件
Box can be equipped with
others electrical accessories
as preferred



电源插座箱

箱体尺寸: 300×400×160mm

SFN-324 2只

DZ47-32/3 2只

DZ47LE-60/3 1只



电源插座箱

箱体尺寸: 220×340×150mm

SF-314 1只

SF-313 1只

DZ47-16/3 1只

DZ47-16/2 1只

组合电源插座箱

A+B+B

SFN-3132 4只

DZ47-16/1 4只

DZ47LE-60/4 1只



电源插座箱

箱体尺寸: 300×520×160mm

SF-313 2只

SF-314 4只

组合电源插座箱

A+B+B+B

SFN-312 2只

SFN-3142 1只

SFN-3242 1只

SFN-3342 1只

NL1E-60/4 1只

DZ47-32/3 1只

DZ47-16/3 1只

DZ47-16/1 2只

DZ158-100/4 1只



组合电源插座箱

A+A+B+B+B

SFN-335 5只

指示灯 220V 1只

CDB2-100/4 1只

DZ47-60/4 5只

灯光照明电源箱

箱体尺寸: 300×520×160mm

SF-413 15只

CDB2-100/3 1只

DZ47-50/1 6只



组合电源插座箱

A+A+B+B+B+B

SFN-312 2只

SFN-313 6只

SFN-324 2只

DZ47-100/4 1只

DZ47-32/3 2只

DZ47-16/1 8只

箱体可根据客户需要定制或内加
装其它电器附件
Box can be equipped with
others electrical accessories
as preferred



电源插座箱

箱体尺寸: 300×520×160mm

SFN-1609 2只

SFN-5623 2只

SFN-5823 2只

DZ47-16/1 2只

DZ47-16/3 2只

DZ47-32/3 2只



电源插座箱

箱体尺寸: 300×400×160mm

SFN-313 1只

SFN-315 2只

SFN-325 1只

DZ47-16/1 1只

DZ47-16/3 2只

DZ47-32/3 1只

不锈钢户外插座箱

箱体尺寸: 320×360×160mm

SFN-3132 2只

SFN-3152 1只

DZ47-16/1 2只

DZ47-32/3 1只

DZ47-60/3 1只



电源插座箱

箱体尺寸: 360×540×180mm

SFN-5623 2只

SFN-5823 2只

DZ47-16/4 2只

DZ47LE-32/4 2只

不锈钢户外插座箱

壳体尺寸: 300×200×400mm

SFN-315 2只

DZ47: 3P 16A 2只



不锈钢户外插座箱

壳体尺寸: 500×700×200mm

SFN-314 3只

SFN-324 3只

DZ47: 3P 16A 3只

DZ47: 3P 32A 3只

不锈钢户外插座箱

壳体尺寸: 400×600×200mm

SFN-3132 1只

SFN-3152 2只

SFN-6352 1只

DZ47: 2P 16A 1只

DZ47: 3P 32A 1只

DZ47: 3P 32A 1只

DZ47: 3P 63A 1只



不锈钢户外插座箱

箱体尺寸: 400×600×160mm

SFN-3132 3只

SFN-3152 3只

DZ47-16/1 3只

DZ47-32/3 1只

DZ47-60/3 3只

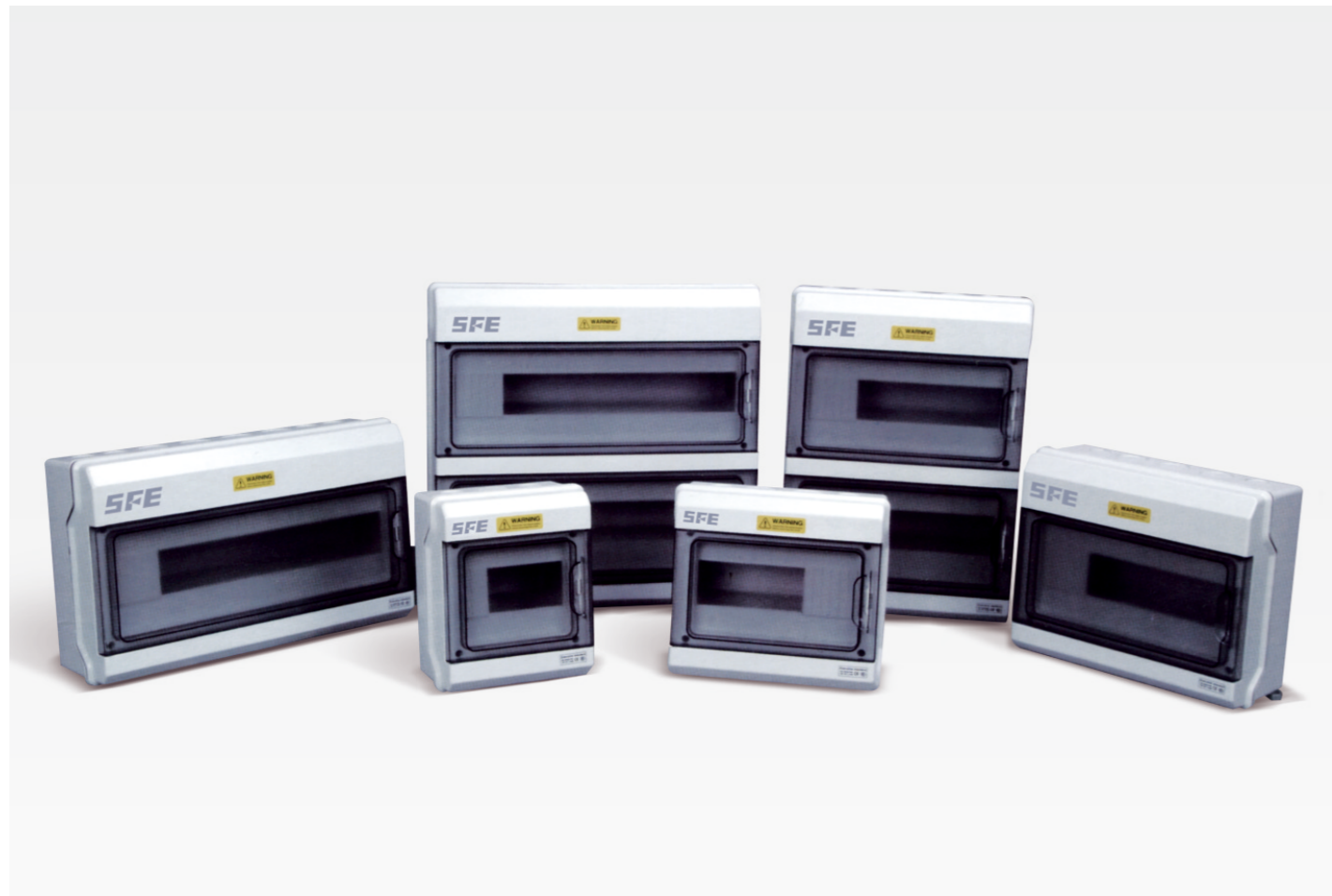

主要特点 Main features

- 外形美观、安装方便、规格齐全、安全可靠、适用于防水、防尘、防腐蚀等特殊场合
- 标准:IEC60529, EN60309
- 防护等级:IP66
- Beautiful in appearance, easy installation, complete specifications, safety and reliable, It's applicable for special, waterproof, dustproof and corrosion-proof location.
- Standard:IEC60529, EN60309
- Degree of Protection :IP66

外形尺寸 Dimensions

回路 Circuit Way	明装 Wall Mounted		
	L(mm)	W(mm)	H(mm)
6way	165	200	100
9way	219	200	100
12way	273	230	110
18way	381	230	110
24way	273	380	110
36way	381	380	110

箱体可根据客户需要定制或内加装其它电器附件 Box can be equipped with others electrical accessories as preferred



主要特点 Main features

- 防水、防蛀、防腐蚀、高绝缘
- 根据客户需求规格开孔, 方便安装
- 阻燃ABS或PC材料
- 标准:IEC60529, EN60309
- 防护等级:IP65
- Waterproof,dustproof,corrosion resistance,high strength insulation
- Opening hole according to user requirements,specifications,eass of installation
- Optional flame retardant ABS or PC material plastic
- Standard:IEC60529, EN60309
- Degree of Protection :IP65

外形尺寸 Dimensions

L(mm)	W(mm)	H(mm)
110	80	70
130	80	70
180	80	70
250	80	70
100	100	75
125	125	75
200	150	100
250	150	100
340	220	150
400	300	160
460	270	160
520	300	160
540	360	180

箱体可根据客户要求定制或内加装其它电器附件 Box can be equipped with others electrical accessories as preferred



SF 50×50

SF 80×50

SF 85×85×50

SF 100×100×70



SF 150×110×70

SF 150×150×70

SF 200×100×70



SF 200×155×80

SF 225×200×80

SF 300×250×120

SF 400×350×120

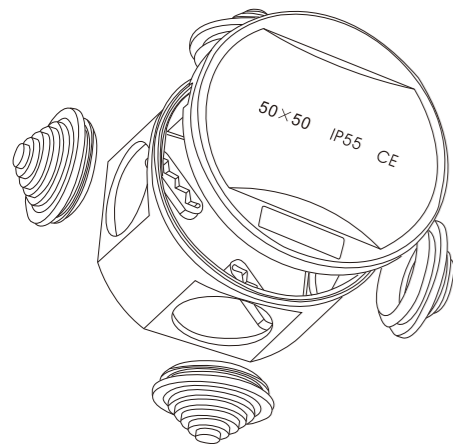

Specification	Dimension				
	L	W	H	孔数	IP
SF 50×50	50		50	4	55
SF 80×50	80		50	4	55
SF 85×85×50	85	85	50	7	55
SF 100×100×70	100	100	70	7	65
SF 150×110×70	150	110	70	10	65
SF 150×150×70	150	150	70	8	65
SF 200×100×70	200	155	80	8	65
SF 200×155×80	200	100	70	10	65
SF 225×200×80	255	200	80	12	65
SF 300×250×120	300	250	120	12	65
SF 400×350×120	400	350	120	16	65



尼龙电缆固定头 Nylon cable gland

材质: UL尼龙66, 防火等级94V-2, 夹紧圈为耐用由橡胶材质。

特点: 1、夹紧圈经特殊设计, 拉力强, 对电机不造成损伤。

2、不须将固定头解体, 电缆可直接穿入上紧即可, 省时方便。

用途: 一般机械控制箱、配电盘、机器、电器等电缆固定用。

Material: Made from UL Nylon 66, 94V-2 and tight ring from rubber.

Feature: 1. Special designation, good strength sile and none damage to electrical machine.

2. Not need to disorganization the fix terminal, cable can be inserted through directly then tighten easy and save time.

Application: Used for machinery control box, distribution plate, machine and electrical. Etc.

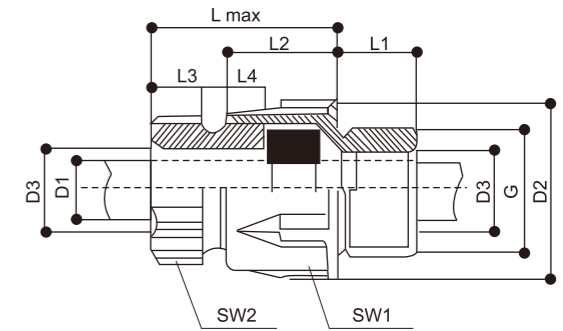

型号 Type	螺纹长度 Thread length L1	进入范围 Entry range D1	螺纹宽度 Entry thread D2	电缆口尺寸 Cable gland dimensions L-L1	防松螺母尺寸 Locknut thread size D3
PG-07	8	3.5-3.6	7	23-8	16.5
PG-09	8	4.5-7	10.2	25-8	21.5
PG-11	8	5.5-10	11.5	27-8	25
PG-13.5	9	9-13	13.5	28-9	27
PG-16	10	10-14	16.5	30-10	30
PG-19	10	14-18	30	10-12	28
PG-21	11	14-18	21	38-11	37.5
PG-25	11	18-25	25	13-18	36
PG-29	11	18-25	27.5	42-11	47.5
PG-36	12	25-33	34.5	43-12	58
PG-42	13	30-38	40.5	48-13	65
PG-48	14	37-44	45.5	48-14	70
PG-63	27	42-50	60	13-18	36

型号 Type	标准螺牙 Threaded entry metric	适用电缆 Cable rangeØ	螺纹外径 Thread o.d.c1	机板口径 Panel mounting hole	螺纹长度 Thread length C2	密封螺母尺寸 Sealing nutsize F	防松螺母尺寸 Locknut size A
MG-12	M12×1.25	7.6-4.6	12	12.5	8.5	19	18
MG-14	M14×1.25	7.6-4.6	14	14.5	8.5	20	19
MG-16	M16×1.5	10-6	16	16.5	15	22	22
MG-18	M18×1.5	10-6	18	18.5	15	25	22
MG-20	M20×1.5	14-9	20	20.5	15	27	27
MG-24	M24×1.5	14-9	24	24.5	15	33	27
MG-25	M25×1.5	18-13	25	25.5	15	33	33
MG-27	M27×1.5	18-13	27	27.5	15	35	35
MG-32	M32×1.5	25-18	32	33	15	41	41
MG-36	M36×1.5	25-18	36	36.5	20	45	41
MG-40	M40×1.5	30-24	40	41	20	50	50
MG-50	M50×1.5	39-30	50	51	22	62	61
MG-63	M63×1.5	48.5-40	63	64	25	75	75